

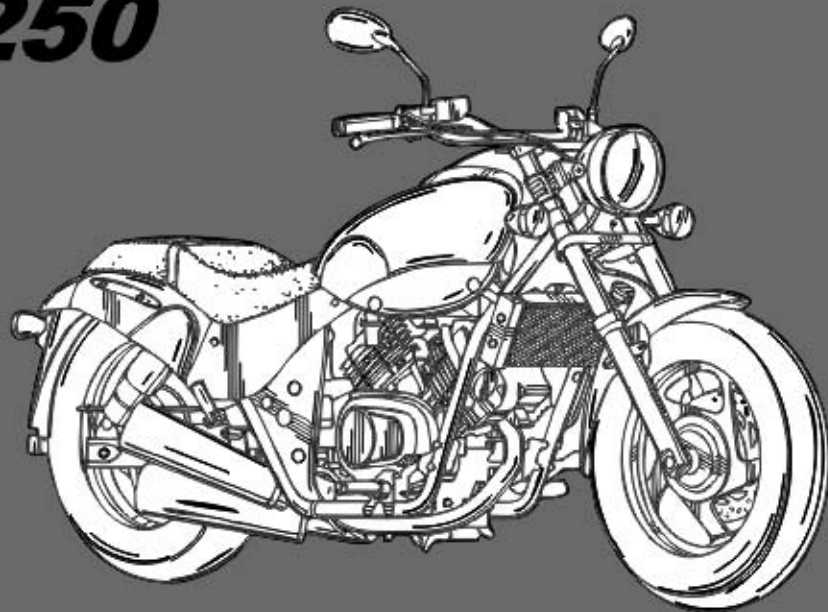

DRIVER'S MANUAL

KWANG YANG MOTOR CO.,LTD.

VENOX 250



Dear KYMCO Motorcycle Users:

Thank you for purchasing this KYMCO bike and welcome to the family of KYMCO bike riders. To enjoy safer and more pleasant riding, become thoroughly familiar with this owner manual before you ride the bike. Your safety depends not only on your own alertness and familiarity with the bike but also the bike mechanical condition. A pre-ride inspection before every outing and regular maintenance are essential. The quality of each KYMCO motorcycle is guaranteed.

Note:1.The information and specifications stated in this manual are for reference only and subject to change without notice.

2.When starting the engine, the battery must be installed to facilitate starting and increase the engine performance.

TABLE OF CONTENTS

1.PRECAUTIONS FOR A SAFE RIDING	2
2.ASSEMBLY PARTS	4
3.OPERATION INSTRUCTIONS	6
IGNITION SWITCH/STEERING HANDLEBAR LOCK	6
ELECTRIC STARTER BUTTON. HEADLIGHT SWITCH	7
ENGINE STOP SWITCH. HORN BUTTON. HEADLIGHT DIMMER SWITCH/ PASSING SIGNAL SWITCH. TURN SIGNAL SWITCH	8
REAR CUSHION. TOOL BOX	10
INSTRUMENTS	11
BRAKE PEDAL ALTITUDE ADJUSTMENT	12
4.PRE-RIDE INSPECTION	13
ADVANCE INSPECTION. ENGINE OIL LEVEL INSPECTION/REFILING	13
BRAKE INSPECTION. TIRE INSPECTION	14
FUEL LEVEL INSPECTION/REFILLING	16
STEERING HANDLEBAR. COOLING SYSTEM INSPECTION	17
BRAKE PEDAL FREE PLAY INSPECTION&ADJUSTMENT	

TABLE OF CONTENTS

BRAKE SHOE INSPECTION	18
HORN/LIGHTS INSPECTION.....	19
DRIVE CHAIN INSPECTION/ADJUSTMENT	
CLUTCH LEVER FREE PLAY INSPECTION	20
FRONT/REAR SHOCK ABSORBER INSPECTION	
BRAKE PERFORMANCE INSPECTION. REARVIEW MIRROR ANGLE CHECK	
LICENSE PLATE CHECK.	
PREVIOUS ABNORMAL PARTS INSPECTION	
LUBRICATION POINT CHECK.....	22
5.ENGINE STARTING METHODS	23
WHEN THE ENGINE IS COLD	23
WHEN THE ENGINE IS WARM	25
6.NORMAL RIDING METHOD	26
STARTING THE ENGINE. REBOUND THE SIDE STAND	26
CORRECT SITTING POSITION. START MOVING.....	27
7.PRECAUTIONS FOR RIDING.....	28

TABLE OF CONTENTS

CORRECT RIDING. SPEED CONTROL-----	28
PROPER RIDING WILL PROLONG THE SERVICE LIFE OF ENGINE	
APPLY BOTH FRONT AND REAR BRAKES WHEN BRAKING-----	29
DO NOT MAKE SUDDEN STOP OR SHARP TURN	
BE MORE CAREFUL WHILE RIDING IN RAINY DAYS-----	30
8.HOW TO STOP RIDING-----	31
WHILE GO NEAR THE PARKING PLACE	
WHILE THE MOTORCYCLE IS COMPLETELY STOPPED-----	31
PARKING. HANDLEBAR-----	32
9.EASY MAINTENANCE-----	33
AIR CLEANER INSPECTION AND AIR CLEANER CLEANING&REPLACEMENT	33
FUEL SYSTEM. APPEARANCE CLEANING-----	34
BATTERY-----	35
FUSE CHANGE-----	36
ENGINE OIL CHANGE-----	37
SPARK PLUG INSPECTION-----	38

TABLE OF CONTENTS

BRAKE FLUID LEVEL INSPECTION/REFILLING	
RUBBER COVER INSPECTION FOR WIRE AND CABLE	39
COOLANT REFILLING	40
COOLANT REPLACEMENT	41
10.IMPORTANT NOTICES	42
WHEN THE ENGINE FAILS TO START OR STOPS DURING RIDING	
IN CASE OF BREAKDOWN	42
POLLUTION-FREE PERIODIC MAINTENANCE SCHEDULE	43
SPECIFICATIONS	44
EUROPEAN AGENTS LIST	45





Location of Frame Serial Number

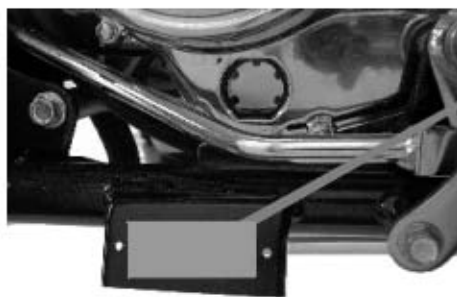
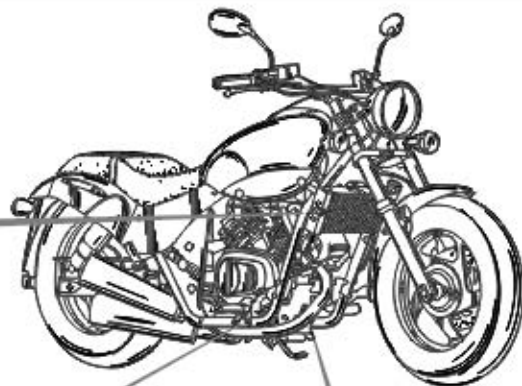

Vehicle Identification Serial Number



Location of Engine Serial Number

1. PRE CAUTIONS FOR A SAFE RIDING

(1) CLOTHES

- To relax and wear comfortable clothes are the main points for a safe riding.
- To observe traffic laws, keep a cool mind, relax and be careful will provide you a safe riding.
- ① Wear helmet and fasten it tightly.
- ② Have the clothes well-arranged. Fasten shirt cuffs and keep them from hooking the brake lever.
- ③ Wear low-heeled shoes for a safe riding.
- ④ When riding, use both hands to grasp the handlebar. It is very dangerous to hold the handlebar with one hand.

▲ CAUTION:

- A motorcycle rider should not wear loose or too long clothes to avoid danger.
- During riding or 10 minutes after the motorcycle is stopped, do not touch the exhaust muffler to avoid scalding.
- When parking the motorcycle, keep it away from dry lawn or inflammables to avoid danger.

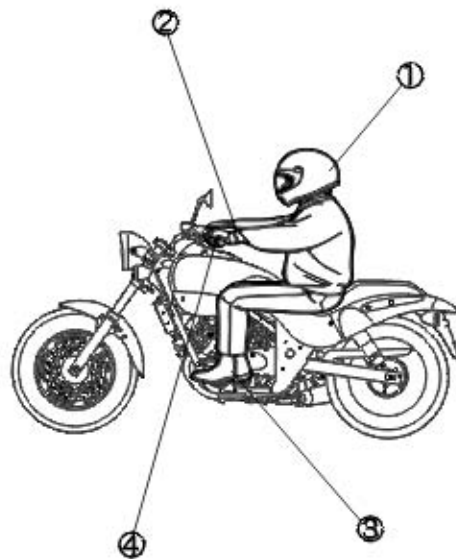

(2) RIDING METHOD

- The safety of two-wheel vehicles is influenced by sitting position. The rider should sit on the central part of the seat cushion. If the rider sits on the rear part of the seat, the load of front wheel will decrease. As a result, the handlebar will swing and cause danger to the rider.
- When making a turn, it will be easier for the rider to steer the motorcycle by leaning the body inward slightly. The motorcycle will lose its balance if the rider fails to keep his body leaning inward.
- When riding on a damaged or macadam road. Slow down the speed and hold the handlebar tightly.



(3) CARRYING GOODS

- Keep a good sitting posture to operate the motorcycle Properly.
- The feel of the handlebar will be different when carrying goods on the motorcycle. Overloading may cause the Handlebar to swing. Avoid riding with overload.



2. ASSEMBLY PARTS

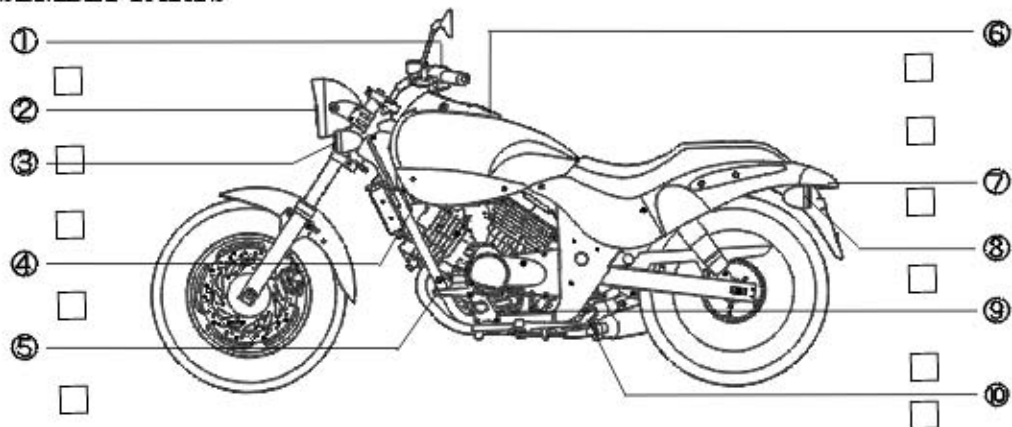

- ① Passing Signal Switch
Turn Signal Switch
Headlight Dimmer Switch
- ② Headlight

- ③ L. Front Turn Signal Light
- ④ Ignition Switch
- ⑤ Change Gear Shift Pedal
- ⑥ Fuel Tank Cap

- ⑦ Taillight/Stoplight
- ⑧ L. Rear Turn Signal Light
- ⑨ Engine Serial Number
- ⑩ Side Stand

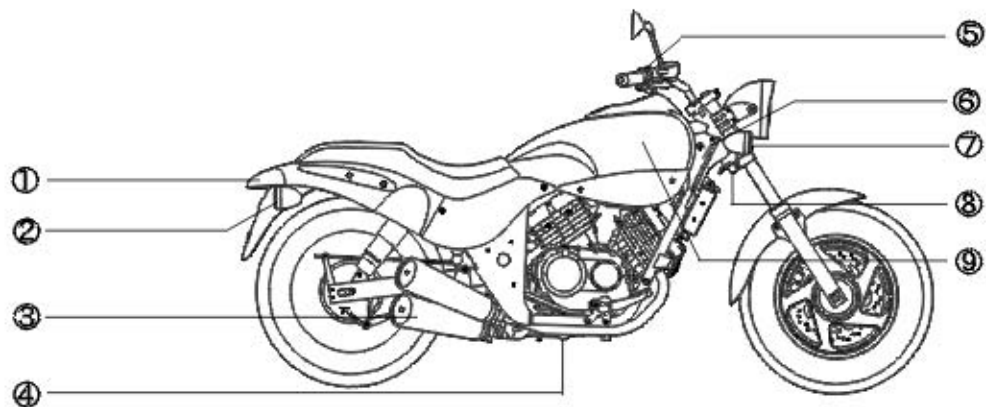

① Taillight/Stoplight

② R. Rear Turn
Signal Light

③ Exhaust Muffler

④ Vehicle Identification
Number

⑤ Headlight Switch &
Electric Starter Button

⑥ Frame Serial Number

⑦ R. Front Turn
Signal Light

⑧ Steering Lock

⑨ Fuel Tank

3. OPERATION INSTRUCTIONS

(1) IGNITION SWITCH/STEERING HANDLEBAR LOCK

- ① ON :At this position, power is connected to start the engine. The key cannot be taken out.
- ② OFF :At this position, power is cut off and the engine stops. The key can be taken out.

《Handlebar》

- ① Lock : Turn the steering handlebar left to the full and then turn the key clockwise to take it out.
- ② Unlock : Turn the key counterclockwise 180° to release the lock.

▲ **CAUTION:**

- Do not turn the ignition switch to "OFF" during riding, It may cause accidents.
- When parking, be sure to lock the steering handlebar to prevent pilferage.
- After locking, turn the handlebar gently to make sure that it is locked.
- Don't park your motorcycle at a place to hinder the traffic.



(2) ELECTRIC STARTER BUTTON

- Release the steering handlebar lock before starting the engine. Turn on the ignition switch and then press the starter button. Make sure to depress the change gear shift pedal into the neutral position to avoid engine damage.

▲ CAUTION:

- During engine running, do not push the electric starter button to avoid engine damage.
- Release the electric starter button immediately after the engine is started.



(3) HEADLIGHT SWITCH

- At this position, the position light, headlight, instrument lights and taillight turn off.
- ☛ At this position, the position light, instrument lights and taillight light turn on together.
- ⚙ At this position, the position light, headlight, instrument lights and taillight light turn on together.



(4) ENGINE STOP SWITCH

- The engine stops at this position and it cannot be started even though the ignition switch is "ON".
- The engine can be started at this position but the ignition switch shall be turned "ON".

▲ CAUTION:

- The engine stop switch is only used for temporary engine stop.
- When the motorcycle is parked and the engine stop switch is not used, be sure to turn "OFF" for the ignition switch to avoid battery overcharge.





(5) HORN BUTTON

- When the ignition switch is turned "ON", press the horn button and the horn will sound.
- The horn switch do not work when the ignition switch is "OFF".





(6) HEADLIGHT DIMMER SWITCH/ PASSING SIGNAL SWITCH

- ①  Switch to this position for using high beam.
- ②  When riding in downtown area or there is a car coming from the opposite direction, use low beam to avoid affecting the visibility of coming cars.
- ③ **PASSING:** When passing, continuously press and release the dimmer switch at the PASSING position and the headlight will wink to warn the coming cars.



(7) TURN SIGNAL SWITCH

- Use turn signal light while turning to another direction or shifting to another lane. The light will wink when the switch is turned on.
- ①  For turning to the right. ②  For turning to the left.
- ③ Push the turn signal switch button to release it.
- The turn signal indicator light will wink when the turn signal switch is operated.
- The turn signal switch do not work when the ignition switch is "OFF".
- The turn signal light will not release automatically. Be sure to reset it after use.



(8) REAR CUSHION

- To suit motorcycle behaviour to load condition, the rear cushion could be adjusted in spring preload.
- Using the special tool in tool kit to change the preload.
- It is possible to adjust rear cushion in five positions:
 - ① ①-② position "soft"
 - ② ③-④ position "medium"
 - ③ ⑤ position "hard"
- When you adjust rear cushion, the spring preload of rear cushions on either side must be the same.

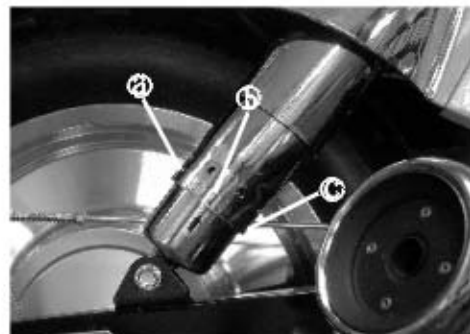

(9) TOOL BOX

- The tools in box are attached to this motorbike and you can put what you need in the rest space, too.

① Max. Loading capacity of the tool box is 1.5kg.

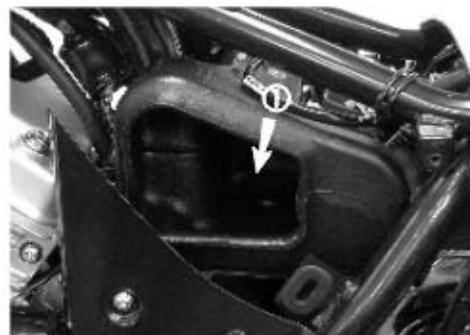

(10) INSTRUMENTS

① ODOMETER:

The total riding mileage is indicated by kilometer.
The figure in black and white is an unit of 100m.

② SPEEDOMETER:

The riding speed is indicated by km/hour.

③ RESET COUNTER:

Use reset button to count interval mileage. Turn the reset button to reset the counter as the arrow shown.

④ TURN SIGNAL INDICATOR:

When the turn signal switch is operated, this indicator light will wink.

⑤ HIGH BEAM INDICATOR:

This indicator light comes on when the long distance light is turned on.

⑥ FUEL RESERVE INDICATOR:

The fuel reserve indicator lights when there is only few fuel left in the tank. Refill nonleaded gasoline as early as possible.

⑦ NEUTRAL POSITION INDICATOR:

When the engine is at the neutral position, this indicator light will come on.

⑧ SIDE STAND INDICATOR:

This indicator light comes on when the side stand is put down.

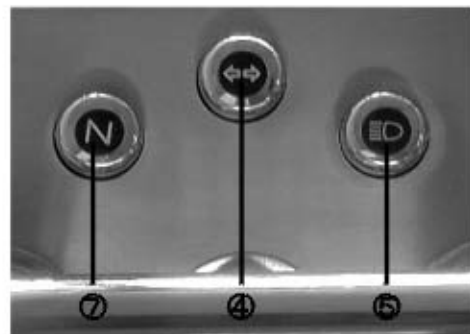
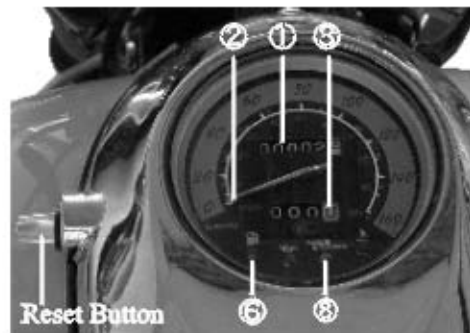

⑨ TEMPERATURE INDICATOR:

It indicates the temperature of engine cooling water. During riding, the temperature indicator shouldn't light. Check the coolant level in the eye hole if the temperature indicator comes on.

⑩ OIL CHANGE INDICATOR:

The indicator will tell you the oil pressure of crank bearing is lower, please check the engine oil level and oil pump.

▲ CAUTION:

- All the instruments and indicators must be kept in good condition to control the motorcycle properly and ensure a safe riding.



(11) BRAKE PEDAL ALTITUDE ADJUSTMENT

- Loosen the six-angle nut to adjust the appropriate altitude of the brake pedal lightly.
- Tighten the nut for accurate adjustment.
- Please also adjust the brake pedal free play with the adjusting nut.



4. PRE-RIDE INSPECTION

(1) ADVANCE INSPECTION

- Get into a good habit of inspection before riding. For the sake of safety and to prevent vehicle damage and traffic accidents, the pre-ride inspection is absolutely required.

▲ CAUTION:

- Be sure to perform inspection and maintenance for your new motorcycle after it is purchased for one month or ridden for 1000km.



(2) ENGINE OIL LEVEL INSPECTION/REFILLING

- Place the motorcycle onto the lifter.
- Check through the sighthole if the oil level is between the upper limit and lower limit.
- If the oil level is below the lower limit, add the engine oil to the upper limit.

▲ CAUTION:

- The temperature of engine and exhaust muffler is very high. When checking the oil level, be careful to avoid scalding.



(3) BRAKE INSPECTION

- Ride the motorcycle at low speed on a dry road and respectively apply the front and rear brakes to check the brake performance.
- The brake lever should have proper free play.
- "Free play" means the distance from the position of loose brake to the position of fully applied brake.
- Measure the free play at the brake lever end and check if it is within the specified value of (10 ~ 20 mm front brake) (10 ~ 20 mm rear brake).

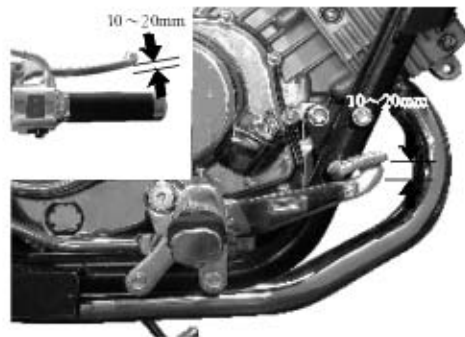

(4) TIRE INSPECTION

1. Tire Pressure Check

- Check if the tire pressure is normal when the tire is in contact with level ground.
- If there is any abnormal condition, check the tire pressure with a tire pressure gauge.
- Measure the tire pressure under room temperature.



2. CRACKS & DAMAGE

- Check the tire-contact area for crack or damage.

3. ABNORMAL WEAR

- Check the tire-contact area for abnormal wear.

4. FOREIGN OBJECTS OF METAL PIECE & GRAVEL

- Check the tires and tire-contact area for imbedded objects of metal piece and gravel.

5. DEPTH OF TIRE GROOVE

- If the tire is worn to the wear limit indication mark, replace it with a new one.

NORMAL PRESSURE(1 Ri der / 2 Riders)	
Front Wheel	2.0/2.0 kg/cm
Rear Wheel	2.00/2.25 kg/cm

▲ CAUTION:

- Abnormal tire pressure, crack, damage and abnormal wear will cause unsteady handlebar and result in tire break.
- If the tire has cracks or is worn to the wear limit indication mark, replace it with a new one.

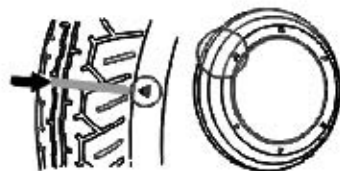

(5) FUEL LEVEL INSPECTION/REFILLING

- Check if the fuel is sufficient.
- If the fuel reserve indicator lights, refill nonleaded gasoline as soon as possible.

《Refilling Method》

1. Open the fuel tank cap protective cover. Insert the ignition switch key into the fuel tank cap lock and turn the key counterclockwise to unlock and open the cap.
2. Use only nonleaded gasoline to fill the fuel tank.
3. When closing the cap, install the fuel tank cap by aligning the tab on the cap with the groove on the fuel filler.
4. When closing, simply press down the fuel tank cap to close it.

Ⓐ Unlock Ⓑ Lock

▲ **CAUTION:**

- Be sure to stop the engine before refilling.
- The gasoline level shall not exceed the reference plate; otherwise the fuel will penetrate out.
- When refilling, do not add other additives to avoid engine breakdown.

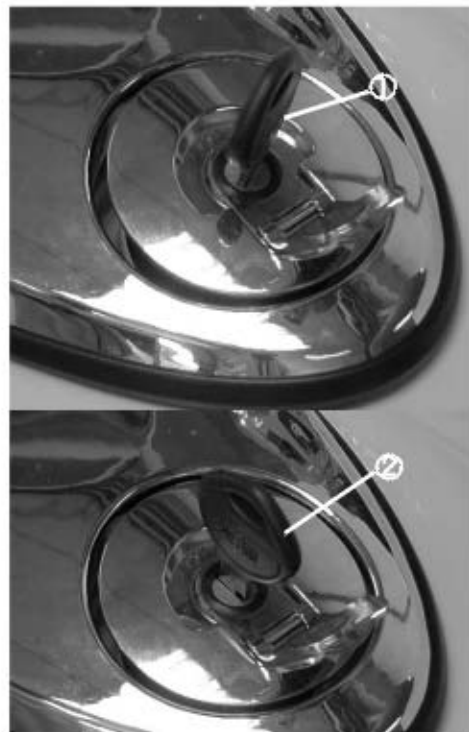

(6) STEERING HANDLEBAR

- Visually inspect the steering handlebar for damage.
- Apply the front brake and move the handlebar upward and downward to check for abnormal noise.
- Move the steering handlebar upward, downward, rightward and leftward to check for any loose parts.
- Check if the handlebar rotates freely.
- If any abnormal condition is found, go to your motorcycle dealer for inspection.

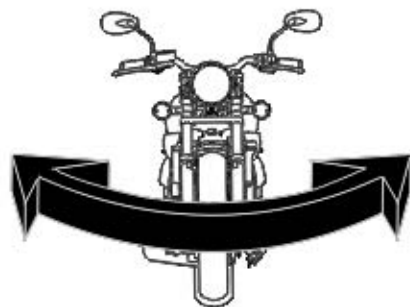

(7) COOLING SYSTEM INSPECTION

1. Place the motorcycle onto the lifter.
 2. Check if the coolant level of the reserve tank is between the upper and lower level lines. If necessary, remove the reserve tank cap and fill to the upper level line with distilled water.
 3. If the coolant level is too low, it means that there are abnormal conditions.
 - Inspect the radiator and hoses for coolant leaks.
 4. Use only distilled water to refill the reserve tank in order to ensure good performance of the cooling system.
- ① Upper Level ② Lower Level

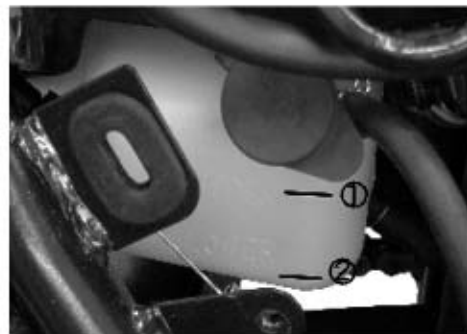

(8) BRAKE PEDAL FREE PLAY INSPECTION & ADJUSTMENT

- Adjust the brake pedal free play with the brake adjusting nuts.
- After adjustment, fully apply the brake pedal and check if the free play is within the specified value (10 ~ 20 mm).

① Increase play ② Decrease play

▲ CAUTION:

- After the brake is adjusted, align the groove of adjusting nut with the pin in order to avoid accident and danger during riding.



(9) BRAKE SHOE INSPECTION

- Check the front brake free play from time to time.
Turn the adjusting nut if adjustment is necessary.

▲ CAUTION:

- Brake shoe will be worn more quickly if the brake lever is always applied lightly during riding.

(10) HORN/LIGHTS INSPECTION

- Turn the ignition switch "ON" and press the horn button to check if it sounds.
- Headlight/Taillight Inspection:
Start the engine and turn on the headlight switch to check if the headlight and taillight are good and check the light shells for dirt and damage.
- Stoplight Inspection:
Apply the front brake lever and rear brake pedal respectively to check if the stoplight is good. And also check the stoplight shell for dirt and damage.
- Turn Signal Light Inspection:
Operate the turn signal switch to make sure whether the right/left front and rear turn signal lights can wink and buzz. Also check the light shells for dirt and damage.

- ① Headlight ② Taillight/ Stoplight ③ Turn signal light
④ Horn button

▲ CAUTION:

- Replace any dirty or damaged lights with new ones to avoid danger during riding.

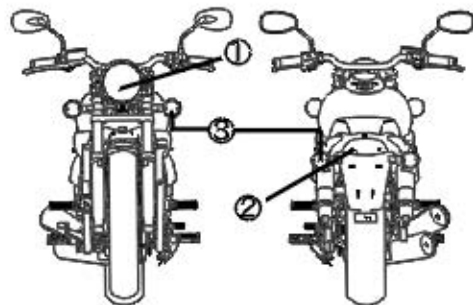

(11) DRIVE CHAIN INSPECTION/ ADJUSTMENT

- The chain should have a slack of 10 ~ 20 mm in its center between the two sprockets.
- Adjustment: Loosen the rear axle nut and turn the adjusting nut until the index mark is aligned with the punch mark on the adjuster. Then tighten the rear axle nut.

①Rear Axle Nut ②Adjusting Nut

- The rear wheel will move backward during adjustment, so the rear brake free play shall also be adjusted.

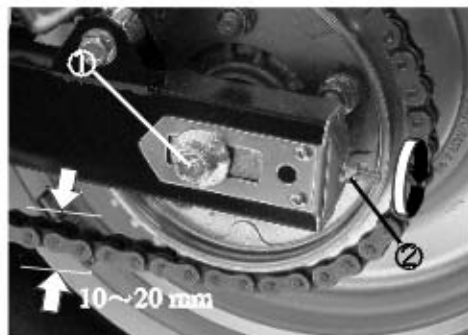

(12) CLUTCH LEVER FREE PLAY INSPECTION

- The clutch lever free play shall be 5 ~ 10 mm. Often check the clutch lever free play and make necessary adjustment by turning the adjusting nut.

①Free Play 5 ~ 10 mm

▲CAUTION:

- If the clutch lever free play is too big or small, the clutch disk will be damaged easily.



CLUTCH ADJUSTING METHOD:

- Adjusting the clutch lever free play with the minor and major adjustment nuts.
- Adjustment by loosening the lock nut and turning the adjusting nut. After adjustment, tighten the lock nut and check if the clutch lever free play is within the specific value.
- Check if the gearshift applied smoothly while running the engine.
- The engine don't allow to be stopped when fully applying the clutch lever and depress the change gear shift pedal into the 1st speed.

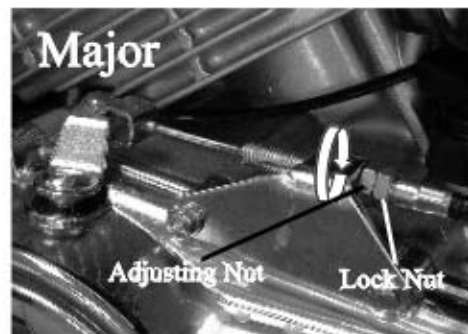

(13) FRONT/REAR SHOCK ABSORBER INSPECTION

- Check the condition of the front/rear shock absorbers by pressing down on the handlebar and seat several times.

(14) BRAKE PERFORMANCE INSPECTION

- Fully apply the front brake lever and rear brake pedal and move the motorcycle forward to see if the braking effect is good.

(15) REARVIEW MIRROR ANGLE CHECK

- Sit on the motorcycle uprightly and make a viewing test of the rearview mirror angle.

(16) LICENSE PLATE CHECK

- Check the license plate for dirt and damage, then tighten it.

(17) PREVIOUS ABNORMAL PARTS INSPECTION

- Make sure that the previous abnormal parts are repaired.

(18) LUBRICATION POINT CHECK

- Visually check if all motorcycle lubrication points are lubricated properly.

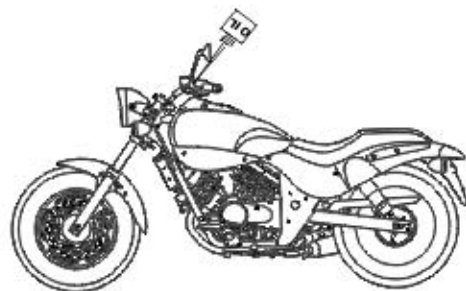

5. ENGINE STARTING METHODS

● WHEN THE ENGINE IS COLD:

1. Unlock the steering handlebar.
2. Check if the engine stop switch is "ON".
3. Turn the ignition switch "ON".

▲ CAUTION:

- Check the gasoline volume and engine oil level before starting the engine.



4. The engine must be started in the neutral position. When the ignition switch is ON, the neutral position indicator comes on.
5. Pull the choke rod outward.
6. Push the electric starter button down when the throttle closed fully.
7. When starting the engine, push slowly the choke rod to its original position until the idling speed runs smoothly.
8. Check if the side stand is rebounded fully.

▲ CAUTION:

- Shift into a proper speed for riding.
- When changing speed, the throttle grip must be turned to the closed position. Then, fully apply the clutch lever and gently depress the gear shift pedal.

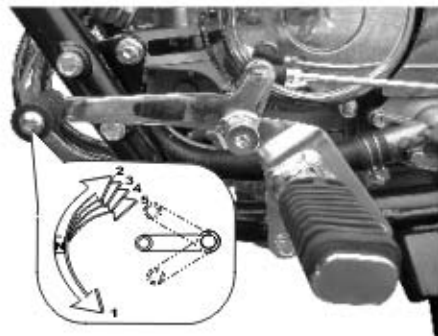

● **WHEN THE ENGINE IS WARM:**

1. Follow steps 1 through 4.
2. Rotate the throttle grip for $1/8 \sim 1/4$ turn.
3. Push the electric button.

▲ **CAUTION:**

- Don't push the electric starter button while the engine is running, otherwise the engine will be damaged.



6. NORMAL RIDING METHOD

(1) STARTING THE ENGINE

- Start the engine by referring to the starting methods specified in Section 5.

▲ CAUTION:

- Keep your finger away from the electric starter button immediately after the engine is started to avoid engine damage.
- The engine must be kept in the neutral position before riding.



(2) REBOUND THE SIDE STAND

- Make sure the throttle is closed before moving the scooter off the side stand.
- Mount the scooter from the left side keeping at least one foot on the ground to steady the scooter.
- Rebound the side stand and push the motorcycle forward.



(3) CORRECT SITTING POSITION

- Ride astride on the motorcycle from the left side and sit upright. Touch the ground with left foot to avoid slipping.

▲ CAUTION:

- The rider must wear helmet and fasten the safety belt securely.
- Do not wear any loose clothes which will affect riding safety.



(4) START MOVING

- Fully apply the clutch lever and depress the change gear shift pedal into the 1st speed with the left foot.
- Slowly rotate the throttle grip and release the clutch lever at the same time. Then the motorcycle will move smoothly.

▲ CAUTION:

- When changing speed, the throttle grip must be turned to the closed position. Then, fully apply the clutch lever and gently depress the change gear shift pedal.

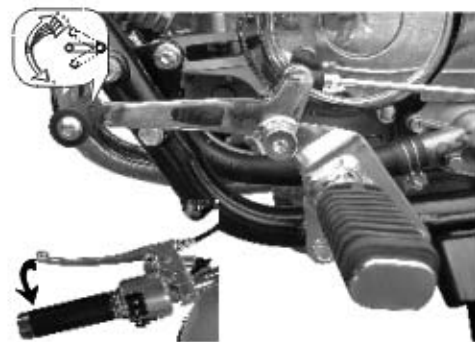

7. PRECAUTIONS FOR RIDING

(1) CORRECT RIDING

- Before moving, turn on the turn signal light and make sure whether the rear side is safe.
- Do not rush into the car lanes and always keep the motorcycle to the correct lanes to avoid danger.

▲ CAUTION:

- Moderate riding will prolong the engine service life. The clutch linings are worn more quickly when often ridden at low speed.

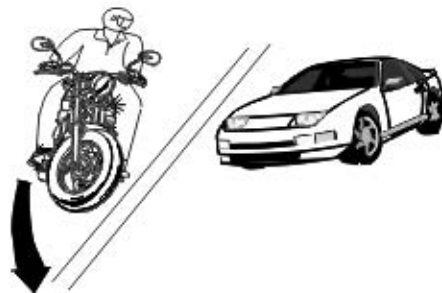

(2) SPEED CONTROL

- The speed is controlled by the throttle grip.
- ① ROTATE The speed will become faster. Don't be hasty to accelerate.
When riding on an ascending road, rotate the throttle grip gradually to increase the horse power.
- ② RESTORE The speed will become slower. Restore the throttle grip quickly.

▲ CAUTION:

- Apply the brake while restoring the throttle grip. This will shorten the time required to slow down.



(3) PROPER RIDING WILL PROLONG THE SERVICE LIFE OF ENGINE

- For a new motorcycle, keep the speed below 60km per hour within the first 1000km of riding
- Avoid sudden acceleration and long-time riding at high speed.
- In hot weather, the engine overheats easily at long-time idling. Stop the engine in this case.

▲ CAUTION:

- Moderate riding will prolong the engine service life.



(4) APPLY BOTH FRONT AND REAR BRAKES WHEN BRAKING

- First restore the throttle grip to the closed position and then pull the brake lever and depress the brake pedal tight.
- The best way to brake the motorcycle is to pull the brake lever and depress the brake pedal "slowly" at the very beginning, then pull them tight.

▲ CAUTION:

- Apply single brake lever will cause the motorcycle to slip.
- During riding, never brake the motorcycle suddenly. It may cause the motorcycle to slip and could be very dangerous.

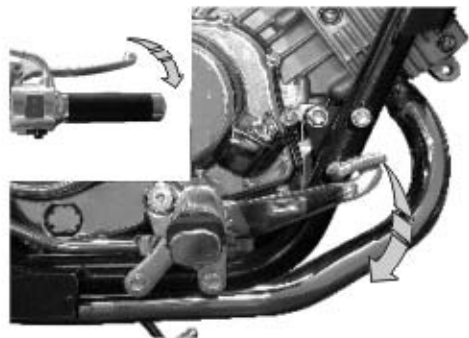

(5) DO NOT MAKE SUDDEN STOP OR SHARP TURN

- Sudden stop and sharp turn are the main causes for slipping and could be very dangerous.
- In rainy days the road is slippery. Sudden stop will cause the motorcycle to slip. Be careful to avoid danger.



(6) BE MORE CAREFUL WHILE RIDING IN RAINY DAYS

- A longer braking distance is required in rainy days than in sunny days. Be sure to slow down and brake the motorcycle slowly as early as possible.
- When riding on a descending road, restore the throttle grip to closed position and slow down by making intermittent braking.

▲ CAUTION:

- A longer braking distance is required in rainy days. Be sure to slow down and brake the motorcycle slowly as early as possible.



8. HOW TO STOP RIDING

(1) WHILE GO NEAR THE PARKING PLACE

- Turn on the turn signal light in advance. Watch out vehicles coming behind or aside and stop the motorcycle to the right side slowly.
- Restore the throttle grip to closed position and apply the front and rear brakes as early as possible.
- At this moment, the stoplight will come on to warn the vehicles coming behind.

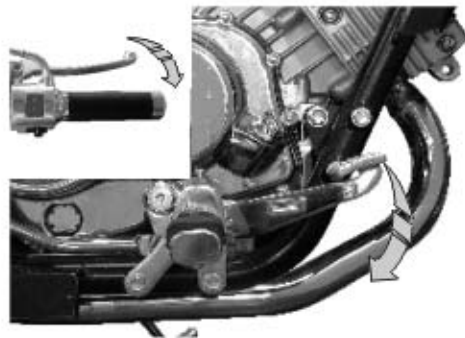

(2) WHILE THE MOTORCYCLE IS COMPLETELY STOPPED

- Return the turn signal switch to its original position.
- Turn the ignition switch "OFF" to stop the engine.

▲ CAUTION:

- During riding, never operate the ignition switch key.
- If the ignition switch is turned "OFF", the electric system does not work which may result in traffic accident.
Operate the ignition switch key after the motorcycle is fully stopped.



(3) PARKING

- Place the motorcycle on its side stand on level ground and do not hinder the traffic.
- Sit on the seat and grip the handlebar straight with left/right hand.
Then, step down the side stand evenly with left foot.

▲ CAUTION:

- The motorcycle may easily fall down if it is parked on an uneven ground.

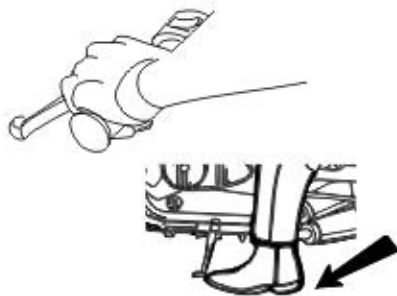

(4) HANDLEBAR

- After parking, be sure to lock the steering handlebar and take out the key to prevent pilferage. (Refer to P6.)

▲ CAUTION:

- Don't park your motorcycle at a place to hinder the traffic.
- The temperature of engine and exhaust muffler is very high. Be careful to avoid scalding.
- Park the motorcycle at a safe place and be sure to take out the key to prevent pilferage.



9. EASY MAINTENANCE

(1) AIR CLEANER INSPECTION AND AIR CLEANER CLEANING & REPLACEMENT

- Take out the air cleaner and visually check if it is dirty or clogged.
 1. Remove the screws attaching the air cleaner cover and remove the air cleaner cover.
 2. Remove the air cleaner element.
 3. The installation sequence is the reverse of removal.
- Clean the air cleaner element with compressed air.
- Replace the air cleaner element at very 20000km.
- The air cleaner requires more frequent cleaning or replacing when ridden in unusually dusty areas. When replacing, refer to P40 Periodic Inspection & Maintenance Schedule.

▲ CAUTION:

- Never use oil or solvent to wash the wet type paper element.
- Be careful not to allow water to enter the air cleaner; otherwise, it may result in hard starting.
- If the air cleaner is not installed properly, dust may be sucked into the cylinder directly to reduce engine horsepower and affect the service life of engine.



(2) FUEL SYSTEM

- Fuel Leakage Inspection
Check the fuel line between the fuel tank and carburetor for fuel leakage.

- ① Fuel tube connector
- ② Fuel tank

▲ CAUTION:

- Check and replace any broken or damaged tube connector to avoid breakdown due to running out of gasoline.



(3) APPEARANCE CLEANING

- Often wipe clean the motorcycle appearance to prevent accumulated dust affecting the function of components.

▲ CAUTION:

- If a motorcycle is not used for a long time, check the operation of each part and replace lubricants before riding. Ride the motorcycle only after its performance is confirmed.
- When waxing the motorcycle, make sure that the ingredients of the wax will not damage the paint of the motorcycle.

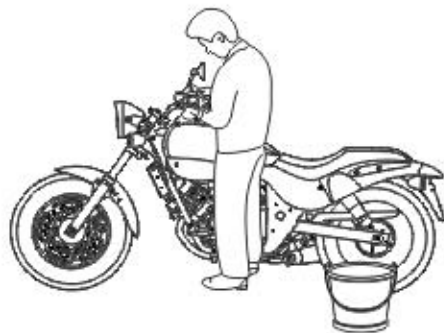

(4) BATTERY

- This model adopts the battery which needs no refilling of distilled water.
- When cleaning the battery terminals, remove the screws attaching the battery cover and then open the battery cover.
- When battery terminals are corroded, take out the battery for cleaning.
- After cleaning, apply a thin coat of grease or Vaseline to battery terminals and then install the battery.

▲ CAUTION:

- Never open the closed-type battery electrolyte cap.
- If the motorcycle will not be used for a long time, the battery will discharge electricity by itself. Remove the battery and put it in a cool place after it is fully charged to prevent electricity leakage.
- If the motorcycle will not be used for a long time, remove the negative (-) terminal.
- Do not smoke or allow flames or sparks near the battery while removing and installing it.
- Turn off the ignition switch before removal or installation. The negative (-) terminal shall be removed first and the positive (+) terminal shall be installed first.
- Tighten the loose terminal nuts securely.

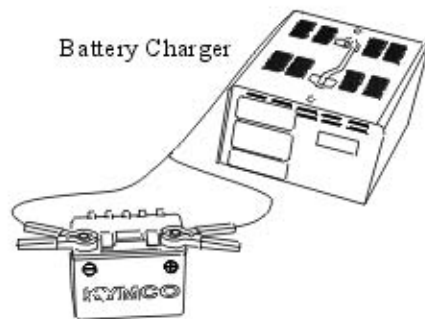

(5) FUSE CHANGE

- Turn off the ignition switch and check if the fuse is burned out.
- When the fuse is burned out, replace with a specified fuse.
- Check for the cause of breakdown before replacing.

Specification

- | | |
|-----------------------|-------------------|
| ① Battery Fuse : 30A | ② Main Fuse : 15A |
| ③ Ignition Fuse : 10A | ④ Lamp Fuse : 15A |
| ⑤ Reserve Fuse : 15A | |



▲ CAUTION:

- Be careful not to excessively expand the fuse clip during removal.
- After a new fuse is installed, check the fuse clip for looseness which is the main cause of trouble.
- Never use fuse of unspecified capacity, it may cause wire overheating and burning out.
- When replacing electric appliances (lights , instruments), be sure to use the recommended genuine parts.
- When washing the motorcycle, avoid flushing it.
- If the cause can not be found, contact our distributor or service station for inspection.

Replacement

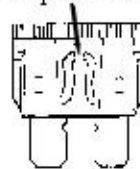

(6) ENGINE OIL CHANGE

1. Place the motorcycle onto the lifter.
2. Remove the oil dipstick.
3. Remove the drain bolt to drain the oil.
4. Refill fresh engine oil for 2.0 liter. Firmly tighten the oil dipstick.
5. Warm up the engine and check the oil level again after the engine is stopped for 20~30 seconds.
 - Specified Oil: SAE 5W-50 API:SF
 - Capacity/Exchanging Capacity:2.5L/2.0 L

▲ CAUTION:

- When changing the engine oil, also clean the oil strainer and reinstall it.
- If temperature is -10°C below, Please must use the specified fully synthetic engine oil: SAE 5W50 API:SF.
- Change engine oil at first 1000km and then change it at every 6000km.
- Engine oil will deteriorate easily and require more frequent change if the motorcycle is often ridden in dusty and cold areas or ridden for short distance.
- Do not mix engine oil of different classes or viscosities. It may cause damage for engine.

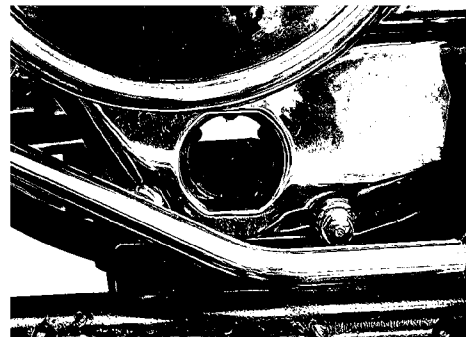

(7) SPARK PLUG INSPECTION

- Check the spark plug side electrodes for wear.
- Fouling deposits on spark plug electrodes and big gap may result in weak spark.
- Spark Plug Removal:
 1. Remove the spark plug with a spark plug remover.
 2. The installation sequence is the reverse of removal.
- Spark Plug Cleaning:
 1. It is better to remove spark plug deposits with a spark plug cleaner.
 2. If a spark plug cleaner is not available, clean with a wire brush.
- The side electrode gap is 0.6 ~ 0.7mm.
- Specified Spark Plug: NGK-CR3E
- ① Spark Plug Cap ② Decarbonizing ③ Cracks, Damage
- ④ Gap, Wear, Fouling Deposits

▲ CAUTION:

- Clean the spark plug at every 6000km and replace it if necessary or when the center electrode is burned out.
- First screw in the spark plug with fingers and then tighten with a spark plug wrench.
- Use unspecified spark plug may damage the engine.

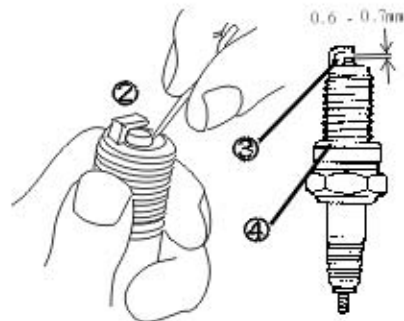

(8) BRAKE FLUID LEVEL INSPECTION /REFILLING

- Remove the 2 screws from the brake fluid tank and take off the cover.
- Add recommended brake fluid DOT-4 into the tank until the fluid level reaches the upper limit and then put on the cover and tighten the screws.
- Recommended Brake Fluid: DOT-4

▲ CAUTION:

- Do not mix brake fluid of different brands. It may cause brake failure and is very dangerous. When refilling brake fluid, use towels to cover and protect the painted and coated surfaces. (Replace at every 10000km or once a year.)



(9) RUBBER COVER INSPECTION FOR WIRE AND CABLE

- The cable cores are protected by the rubber cover outside the connector. Check the rubber cover frequently for proper installation.
- When washing the motorcycle, do not flush the rubber cover directly or brush it. Use a wet rag to wipe off dirt and dust.

- ① Rubber Cover
- ② Check Points

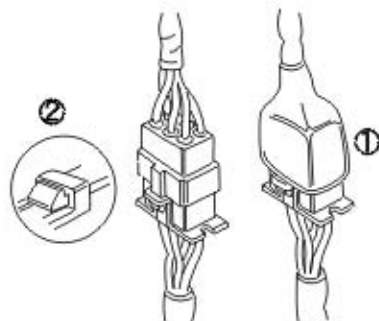

(10) COOLANT REFILLING

1. Place the motorcycle onto the lifter.
 2. Remove the reserve tank cap and fill to the upper level line with distilled water.
- If the coolant level is too low, it means that there are abnormal conditions.
 - Coolant concentrate specified density: 30%(cold area 50%)

Density & Freezing Point:

25% : -12 °C 40% : -24 °C

30% : -15 °C 50% : -35 °C

Total coolant capacity : 1030cc.

① Reserve tank cap

▲ CAUTION:

- Use distilled water to make coolant mixture.
- Be careful not to use coolant of inferior quality which may shorten the radiator service life.
- Replace the coolant once a year or at every 10000 km under normal use.

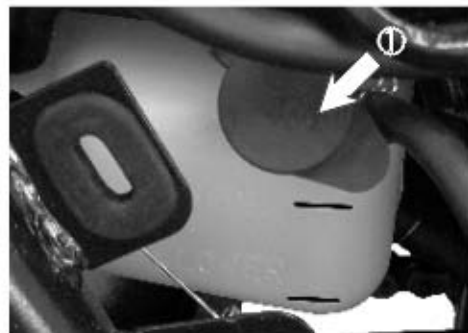

(II) COOLANT REPLACEMENT

Coolant Draining

1. Press down the reserve tank cap and turn it counterclockwise to remove it.
2. Remove the drain bolt to drain the coolant. Tilt the motorcycle to the right and the coolant will drain more easily.

Coolant Filling

1. Install the drain bolt.
2. First fill the reserve tank with coolant to the upper level line.
3. Install and securely tighten the reserve tank cap.
4. Start the engine and allow the cooling fan to run for at least 2 times. Then, stop the engine. (The engine must be cool before removing the reserve tank cap, or severe scalding may result.)
5. Remove the reserve tank cap and add coolant up to the proper level if necessary. Then, reinstall the reserve tank cap.
6. Wait for 2 ~ 3 hours until the engine is cold. Check the coolant level in the reserve tank and fill to the upper level line if the level is under the lower level line.

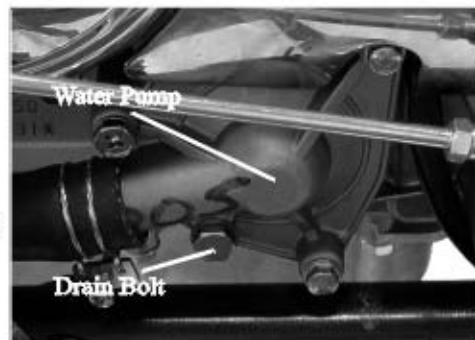

▲ CAUTION:

- When removing the radiator pressure cap, be more careful because the coolant is under pressure and severe scalding could result. Wait until the temperature is lowered. Then, cover the reserve tank cap with a towel and then remove it slowly.
- Avoid spilling coolant on painted surfaces. Once it happens, immediately flush with fresh water.

10. IMPORTANT NOTICES

(1) WHEN THE ENGINE FAILS TO START OR STOPS DURING RIDING

- Is the gasoline enough?
- If the fuel indicator lights, refill nonleaded gasoline.
- Is the way to start the engine correct?
- Is there any other faulty parts?

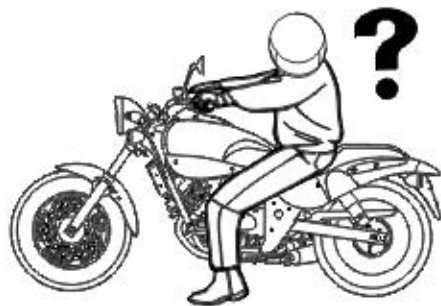

(2) IN CASE OF BREAKDOWN

- For any trouble occurred during riding , go to a KYMCO distributor or service station for inspection.

▲ CAUTION:

- For the sake of safety and to prevent vehicle damage and save your precious time, the pre-ride inspection is absolutely required. Please read this User's Manual carefully and get into a good habit of inspection before riding.



(3) POLLUTION-FREE PERIODIC MAINTENANCE SCHEDULE

- In order to have a safe riding, maintain good performance, prolong the motorcycle service life and reduce pollution, make sure to perform the periodic inspection and maintenance.

I: Inspect and clean, lubricate, refill, repair or replace if necessary.

A: Adjust C: Clean R: Replace T: Tighten

Item	✓	Regular Service Mileage (KM)									Daily Pre-ride Inspection
	4Stroke	1000	7000	13000	19000	25000	31000	37000	43000	50000	
✓ Engine Oil	○	R	R	R	R	R	R	R	R	R	I
✓ Engine Oil Strainer	○	R	C	R	C	R	C	R	C	R	
Gear Oil	✗	R		R		R		R		R	
✓ Cooling Water	✗	• Clean at every 10000 km or once a year.									I
✓ Spark Plug	○	• Clean (C) at every 6000km or replace (R) if necessary.									
✓ Valve Clearance	○		A		A		A		A		
✓ Carburetor	○			I		I		I		I	
Drive Belt	✗		I			I				I	
✓ Drive Chain	○		A	A	A	A	A	A	A	A	
✓ Air Cleaner	○	• Replace (R) at every 20000km .									
✓ Battery Electrolyte	○		I	I	I	I	I	I	I	I	I
✓ Fuel Filter Screen	○					R					
✓ Brake System	○		I	I	I	I	I	I	I	I	I
✓ Clutch Lever Free Play	○	A		A	A	A	A	A	A	A	
✓ Bolts & Nuts	○	T			T			T			
✓ Tire Pressure	○		I	I	I	I	I	I	I	I	I
Motor Oil Strainer	✗										
Engine Oil Pump	✗	I		I		I		I			

• The above items are applicable to different models. Perform suitable items for each model.
 • When exceeding the listed mileages, perform maintenance according to the listed intervals.
 • The air cleaner requires more frequent cleaning or replacing when ridden in unusually dusty areas.

(4) SPECIFICATIONS

Engine Type	DOHC water cooled 4-stroke twin cylinder	Overall Length	2325 mm
Displacement	249.4 cc	Overall Width	840 mm
Bore x Stroke	58x47.2 mm	Overall Height	1080 mm
Compression Ratio	11.2 : 1	Dry Weight	175 kg
Max. Output	20.6/10500 kw/rpm	Wheel Base	1620 mm
Max. Torque	19.8/8500 N.m/rpm	Ground Clearance	150 mm
Idle Speed	1300 rpm	Tire Size	FR: 120/80-17 RR: 150/80-15
Transmission Type	Left foot operated gear shift pedal	Fuel Type	nonleaded gasoline
Clutch	Wet Multi-Disc Clutch	Oil Tank Capacity	2.5 liter
Ignition	C.D.I.+T.P.S	Fuel Tank Capacity	14 liter
Starting System	Starting motor	Engine Oil Type	SAE 5W-50 SF
Spark Plug	NGK-CR8E	Battery	12V 8AH
Brake Type	Disk/Drum	Fuse	30A



KYMCO

KWANG YANG MOTOR CO.,LTD.
NO.35 Wan Hsing Street, San Min District
Kaohsiung, Taiwan, Republic of China
Telephone : 886-7-3822526
FAX : 886-7-3950021