



KYMCO



Quannon 150
OWNER'S MANUAL

Do not remove this Owner's Manual from the vehicle. Read this manual carefully before operating the vehicle as it contains important safety information.

Read this manual carefully.

This Owner's Manual contains important information on safety, operation and maintenance of your KYMCO motorcycle. Any one who operates your motorcycle should carefully read and understand the contents of this manual before riding the motorcycle. For your safety, understand and follow all of the warnings contained in this Owner's Manual and the labels applied to your motorcycle. This Owner's Manual should be considered a permanent part of the vehicle. Keep it with your motorcycle at all times. **ON-ROAD USE ONLY.** This motorcycle has been designed to be used on the road.

Particularly important information is called out in this manual by the following icons and notations:



The SAFETY ALERT symbol with the exclamation point in the triangle means ATTENTION! BE ALERT! YOUR SAFETY CAN BE AFFECTED.



Failure to follow instructions associated with a WARNING symbol could result in severe injury or death to the rider, a passenger, a bystander, or a person inspecting or repairing the motorcycle.



A CAUTION symbol indicates that special precautions must be taken to avoid damaging the motorcycle.



The NOTE symbol indicates key information about a procedure or to clarify an operation.

California Proposition 65



This product contains or emits chemicals known to the State of California to cause cancer and birth defects or other reproductive harm.

Battery & Electrical System Damage Alert



To avoid damage to the motorcycle's electrical system, do not remove or install a battery wire when the ignition switch is in the "ON" position.

Manual Icon Legend	(inside of front-cover)	
CA Prop 65 & Battery Warning	(inside of front-cover)	
Table of Contents	1	
SECTION 1 - SAFETY	2 - 8	
Forward	2	
Motorcycle Safety	3 - 4	
Load Limits & Guidelines	5	
Accessories & Modifications	6	
Caution & Warning Labels	6	
Locations of Parts & Controls	7 - 8	
SECTION 2 - CONTROLS & FEATURES	9 - 21	
Serial Numbers	9	
Keys	10	
Ignition Switch	10	
Steering Lock	10 - 11	
Right-hand Handlebar Switch	12	
Left-hand Handlebar Switch	13	
Helmet Lock	14	
Seat Lock	14	
Tool Kit	14	
Multifunction Meter	15 - 21	
Speedometer	17	
Odometer/Trip meter/Service meter	18 - 19	
Fuel Level Gauge	20	
Clock	20 - 21	
SECTION 3 - OPERATION	22 - 40	
Pre-ride Inspection	22 - 31	
Engine Oil Inspection	23	
Brake Inspection	24	
Tire Inspection	25	
Fuel Level Inspection & Refilling	26	
Steering Inspection	27	
Lights Inspection	27	
Horn Inspection	28	
Drive Chain Inspection	28	
Clutch Lever & Cable Inspection	29	
Throttle Inspection	30	
Chassis Inspection	31	
Starting the Engine	31 - 33	
Riding Your Motorcycle	37 - 40	
Stopping & Parking Your Motorcycle	37 - 38	
Break-in Recommendations	39 - 40	
Tire Break-in	40	
SECTION 4 - MAINTENANCE	41 - 58	
Importance of Maintenance	41	
Maintenance Schedule	42 - 43	
Engine Oil Recommendation	44	
Engine Oil Change	44 - 45	
Spark Plug	46 - 47	
Air Filter Element	47 - 48	
Throttle Free-play Adjustment	49	
Brake Fluid	49 - 50	
Battery	50 - 51	
Battery Removal & Service	51	
Wire Connectors	52	
Fuses	52	
Cleaning Your Motorcycle	53 - 54	
Storage	55 - 56	
Maintenance Record	57 - 58	
Specifications	59	
Exhaust Emissions System	60 - 61	
Clean-air System	61	
Emission Information & EPA Warranty	62	
KYMCO Limited Motorcycle Warranty	63	
Index	64	
Identification Numbers Record	(inside of back-cover)	

SECTION 1 - FORWARD & SAFETY INTRODUCTION



Thank you for purchasing this KYMCO Quannon motorcycle, and welcome to the KYMCO riding family.

Please read this Owner's Manual carefully before riding so that you will be thoroughly familiar with the proper operation of your motorcycle's controls, its features, capabilities, and limitations.

To ensure a long, trouble-free life for your motorcycle, provide it with the proper care and maintenance as described in this manual.

For replacement parts and accessories, you should always use genuine KYMCO products, as they have been specially designed for your vehicle and manufactured to meet KYMCO's demanding standards.

Keep this Owner's Manual aboard your motorcycle at all times so that you can refer to it whenever you need information. This manual should be considered a permanent part of the motorcycle and should remain with the motorcycle when it is sold.

All information, illustrations, photographs and specifications contained in this manual are based on the latest product information available at the time of publication. Due to improvements or other changes, there may be information in this manual that differs slightly from your vehicle. KYMCO reserves the right to make product and publication changes at any time without notice and without incurring any obligation.

IMPORTANT SAFETY INFORMATION

Your motorcycle can provide you many years of service and pleasure if you take responsibility for your own safety and understand the challenges that you can meet on the road. There is much that you can do to protect yourself when you ride. You will find many helpful recommendations throughout this manual. Here are some very important safety tips:

Wear a helmet

Motorcycle safety equipment starts with a quality helmet. One of the most serious injuries you can suffer in a crash is a head injury. Always wear a properly approved helmet. You should also wear suitable eye protection.

Make yourself easy to see

To make yourself more visible, wear bright reflective clothing, position yourself so other drivers can see you, signal before turning or changing lanes, and use your horn when it will help others notice you.

Know your limits

Ride within the boundaries of your own skill at all times. Knowing these limits and staying within them will help you to avoid accidents.

Keep your motorcycle in safe condition

For safe riding, it's important to inspect your motorcycle before every ride and perform all recommended maintenance. Never exceed load limits, and only use accessories that have been approved by KYMCO for this motorcycle.

Inspect your motorcycle before riding

Do not forget to perform an entire safety inspection to ensure the safety of you and your passenger before each ride.

Be extra safety conscious on bad weather days

Riding on bad weather days, especially wet ones, requires extra caution. Braking distance can double on a rainy day. Stay off of the painted surfaces, manhole covers and greasy appearing areas on the pavement, as they can be especially slippery. Use extreme caution at railway crossings and on metal gratings and bridges. Whenever you are in doubt about the road conditions, slow down.

Modification

Modification of your motorcycle, or removal of original equipment may render the vehicle unsafe or illegal. Obey all applicable equipment regulations in your area.

PROTECTIVE APPAREL

For your safety, always wear an approved motorcycle helmet, eye protection, boots, gloves, long pants, and a long-sleeved shirt or jacket whenever you ride your motorcycle.

Helmets and protection

Your helmet is your most important piece of riding gear because it offers the best protection against head injuries. Your helmet should fit your head comfortably and securely. Always wear a face shield or goggles to protect your eyes and to aid your vision.

Additional riding gear

In addition to a helmet and eye protection, you should also use:

- Sturdy boots with nonslip soles to help protect your feet and ankles
- Leather gloves to keep your hands warm and help prevent blisters, cuts, burns and bruises
- A motorcycle riding suit or jacket that has been designed for comfort as well as protection. Bright colored and reflective clothing can help make you more noticeable in traffic. Be sure to avoid any loose clothing that might get caught on any part of your motorcycle.

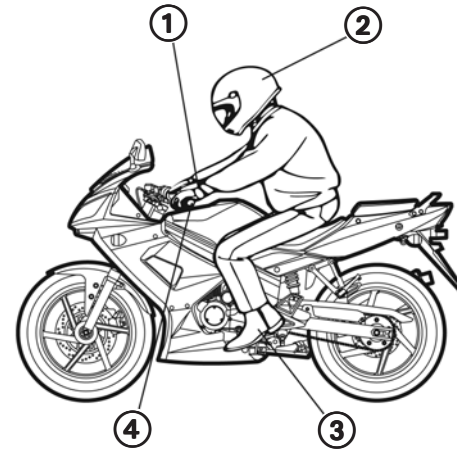

- ① Wear bright or reflective clothing. Your clothes should fit properly (not too tight or loose)
- ② Always wear a helmet and wear eye protection
- ③ Your footwear should be the proper size, have low heels, and offer ankle protection
- ④ Wear gloves and always ride with both hands grasping the handlebars

WARNING

Not wearing a helmet increases your chance of serious injury or death in a crash.

WARNING

Be sure you and your passenger always wear approved motorcycle helmets that fit properly. You should also wear eye protection and other protective apparel when you ride.

Your riding position

The riding stability of your motorcycle is influenced by your riding position. When riding, you should sit on the center of the seat. If you sit on the rear of the seat you could reduce the amount of weight on the front wheel. This could affect the handling and steering characteristics of the motorcycle.

Your motorcycle will turn more smoothly if you lean your body into the turn. Use caution with extreme leaning or handlebar inputs that could upset the chassis.

When riding your motorcycle on a rough or slippery road, reduce your speed and hold the handlebars firmly. Be prepared to brake or turn to avoid a road hazard.

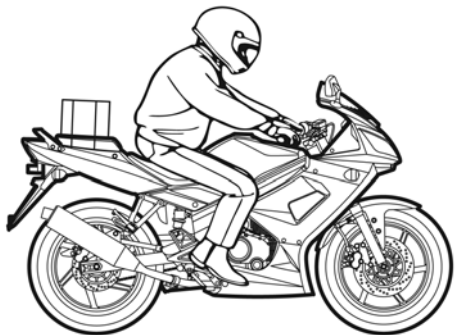

Load limits

These specifications are the load limits for your Quannon motorcycle. These general guidelines may help you decide how to add accessories to your motorcycle and how to load it properly.

Overloading will affect the motorcycle's stability and handling, be sure to stay within the limits given below:

Maximum weight capacity (Includes the weight of the rider, passenger, cargo and accessories): 810 lbs (368 kg)

Maximum cargo weight: 308 lbs (140 kg)

Loading guidelines

Improperly loading your motorcycle will affect its stability and handling. You should ride at reduced speeds when you are carrying a passenger or cargo. Follow these guidelines whenever you carry a passenger or cargo:

- Check that both tires are properly inflated
- To prevent loose items from creating a hazard, make sure all cargo is securely tied down before you ride
- Balance cargo weight evenly on the motorcycle

WARNING

Overloading or improper loading will affect vehicle handling, stability and braking, and can lead to an accident. Never exceed the stated load capacity of your motorcycle. Cargo should be properly distributed and securely attached. Reduce speed when carrying cargo. Allow greater distance for braking.

Accessories

There is a large variety of accessories available to KYMCO motorcycle owners. KYMCO cannot have direct control over the quality or suitability of accessories you may wish to purchase. The addition of unsuitable accessories to your motorcycle can lead to unsafe operating conditions. It is not possible for KYMCO to test each accessory on the market or combinations of all the available accessories; however, your KYMCO dealer can assist you in selecting and installing quality accessories.

Use extreme caution when selecting and installing the accessories for your motorcycle.

No modifications

KYMCO strongly advises you against removing any original equipment or modifying your motorcycle in any way that would change its design or operation.

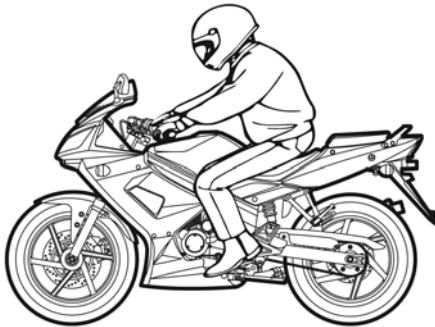

WARNING

Improper accessories or modifications can make your motorcycle unsafe and can lead to an accident.

Never modify your motorcycle through the improper installation or use of accessories. All parts and accessories added to this vehicle should be genuine KYMCO or equivalent components designed for use on this motorcycle, and should be installed and used according to instruction. If you have any questions, consult an authorized KYMCO dealer.

Caution labels

Your KYMCO Quannon motorcycle comes equipped with several labels and hangtags containing important safety information. Anyone who rides your motorcycle should read and understand this information before operating it. The labels should be considered permanent parts of the vehicle. If a label comes off or becomes hard to read, contact your KYMCO dealer immediately for a replacement.

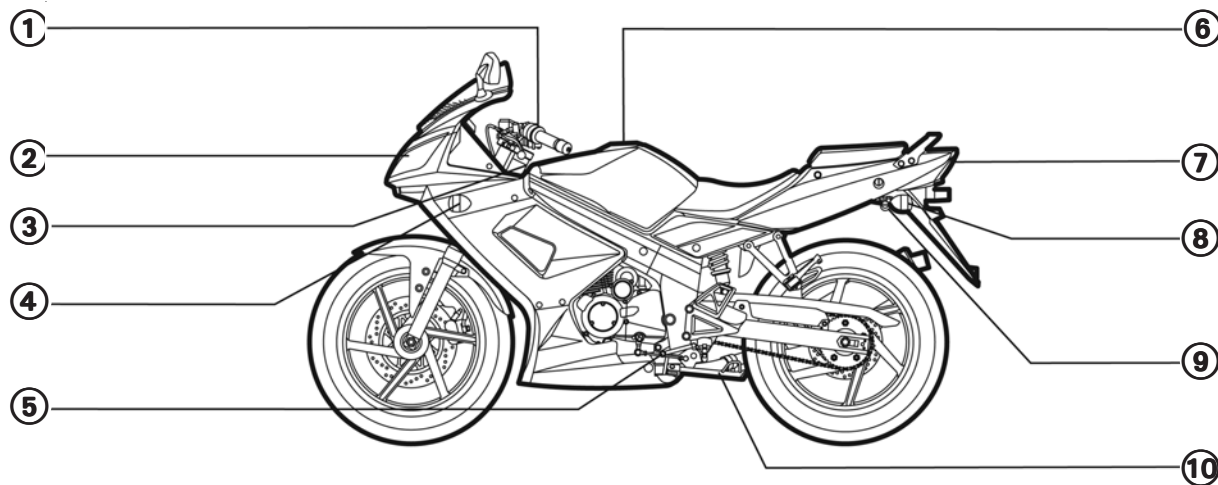

① Headlight dimmer switch, passing button, turn signal switch, and horn button

② Headlight

③ Ignition switch

④ left front turn signal

⑤ Transmission shift lever

⑥ Fuel tank cap

⑦ Taillight/Stoplight

⑧ Left rear turn signal

⑨ Helmet lock

⑩ Side stand

■ NOTE: Your motorcycle may differ slightly in appearance from the images in this manual.

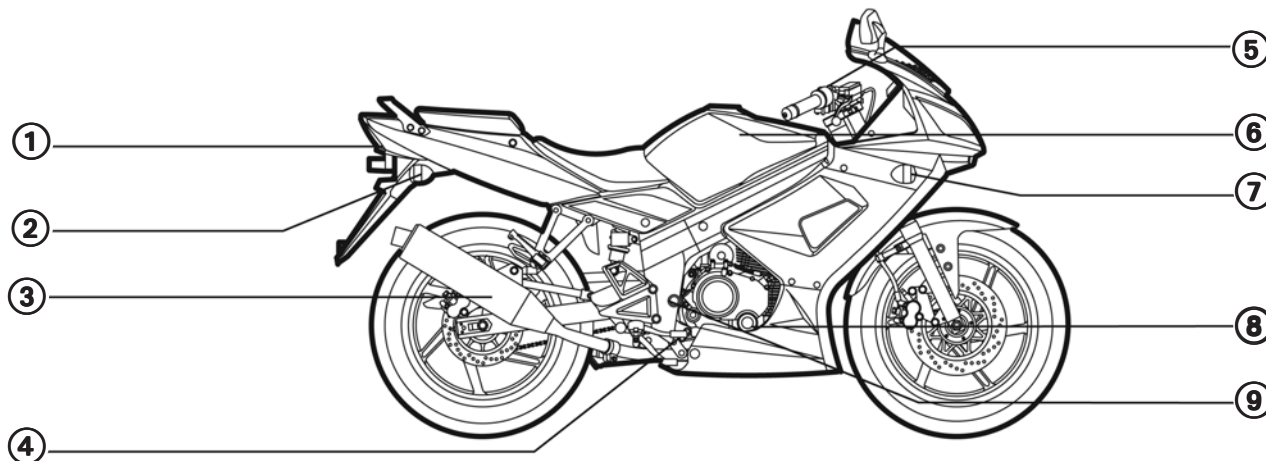

- ① Taillight/Stoplight
- ② Right rear turn signal
- ③ Exhaust muffer

- ④ Rear brake pedal
- ⑤ Engine stop switch and starter motor button
- ⑥ Fuel tank

- ⑦ Right front turn signal
- ⑧ Oil level window
- ⑨ VIN (frame number)

SECTION 2 - CONTROLS & FEATURES

Vehicle identification number

The vehicle identification number (also known as the VIN or frame number) is a 17-digit number stamped on the right side of the frame. At this same location is the VIN compliance label. When you take delivery of your motorcycle, check that the VIN stamped on your motorcycle and imprinted on the label is the same as the VIN listed in the bill-of-sale and the warranty documents you receive from your dealer.

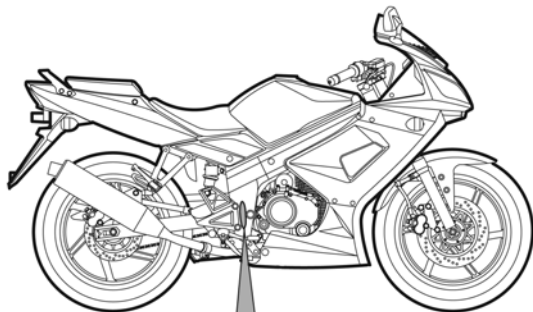

Engine serial number

The engine serial number (also known as the ESN) is stamped on left side of the engine case.

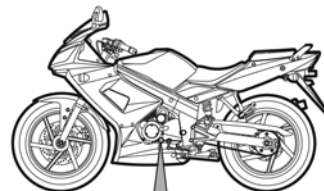

NOTE: Write your motorcycle's VIN and ESN in the boxes provided in the inside, rear cover of this Owner's Manual.

KEYS

Your Quannon motorcycle is supplied with two identical ignition switch keys that operate the ignition switch, the steering lock, the fuel filler cap, and the helmet lock.



Both keys have a unique code stamped on the tab supplied with the keys. For security reasons this code is not stamped on the motorcycle or recorded in the vehicle's basic documentation. Since the code is required if you need replacement keys, record these important codes in the boxes provided on the inside, rear cover of this Owner's Manual.

NOTE: Apply a lock lubricant with antifreeze properties to key openings if the outside air temperature drops below freezing (32° F, 0° C).

IGNITION SWITCH & STEERING LOCK

To operate the ignition switch and the steering lock:

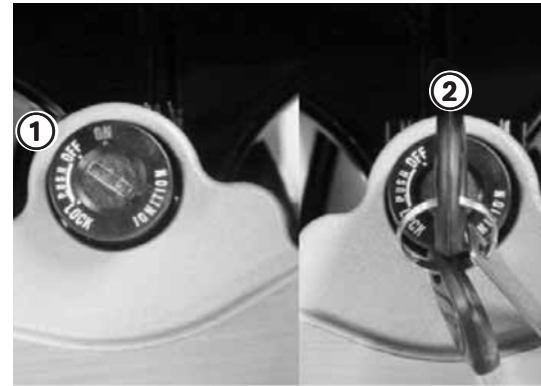

- ① "OFF": In this position, the motorcycle's electrical system is off, and the engine cannot be started. The key can be removed from the ignition switch in this position.
- ② "ON": In this position, the motorcycle's electrical system is on, and the engine can be started. The key cannot be removed from the ignition switch in this position.
- ③ "LOCK": In this position, the ignition switch locks the steering of the motorcycle. The key can be removed from the ignition switch in this position.

**⚠ WARNING**

Do not turn the ignition switch to the "OFF" or "LOCK" positions while riding, as this may cause an accident.

When parking (and locking) your motorcycle, do not leave it in a place where it can hinder pedestrian or vehicular traffic.

Using the steering lock:

LOCKING: Turn the handlebars fully to the left, then push in and turn the ignition switch key to the "LOCK" ③ position. Remove the key. The steering should now be locked.

UNLOCK: Turn the ignition switch key to the "OFF" ① or the "ON" ② position to unlock the steering.

⚠ CAUTION

After locking the steering, gently turn the handlebars to make sure the lock is engaged.

Right handlebar switch

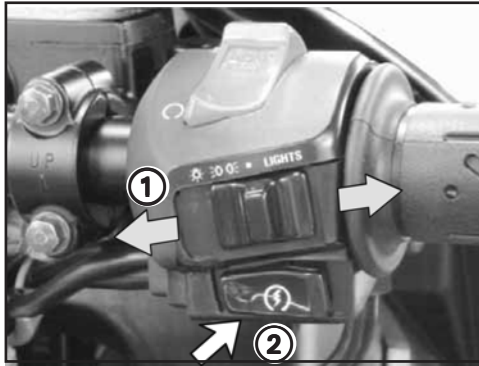

Headlight switch ① "☀️" position:

The headlight and taillight will be lit.

"☁️" position:

The position light and taillight (running lamps) will be lit.

"•" position:

The headlight and taillight will be off.

NOTE: Not all Quannon motorcycles have switches that control the headlight circuit. Depending upon country and state regulations, your motorcycle's controls may differ from the switches described here.

Electric starter button ② "🔌":

Turn the ignition switch "ON" and press the electric starter button to activate the starter motor.

NOTE: The starter motor will not engage unless the front brake lever is squeezed or the rear brake lever is depressed at the same time the starter button is pressed.

⚠️ CAUTION

Release the starter button immediately after the engine has started.

To prevent damage to the starter motor, do not operate the starter motor for more than five seconds at a time.

If the motorcycle fails to start immediately, check the fuel level and the battery condition. Allow the starter motor to cool before attempting to start the engine again.

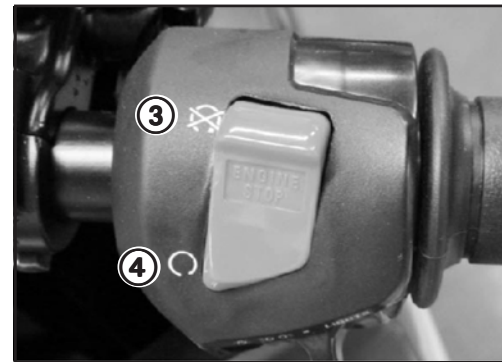

Engine stop switch ③ "🛑" position:

The ignition circuit is off. The engine will not start or run.

Engine stop switch ④ "🏍️" position

The ignition circuit is on, and the engine can start and run.

Left handlebar switch

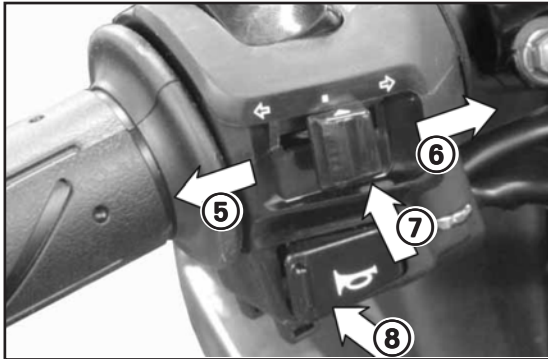

Turn signal switch:

Use the turn signal indicator to signal to other traffic that you intend to turn or change lanes. The turn signal light on the dash will flash to alert the rider that the switch is engaged.

"←" for turning to the "left" ⑤.

"→" for turning to the "right" ⑥.

To cancel the turn signal, press the switch in when it is in the center position ⑦.

NOTE: The turn signals do not automatically cancel. Be sure to cancel your signals each time you complete a turn or lane change.

Horn button ⑧ "📢":

Press the horn button to sound the horn.

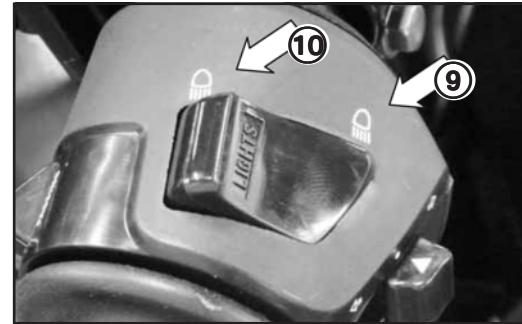

Dimmer switch:

"☞" switch position ⑨ turns the headlight low beam on.

"☞☞" switch position ⑩ turns the headlight high beam on. The high beam indicator light on the dash is activated as well.

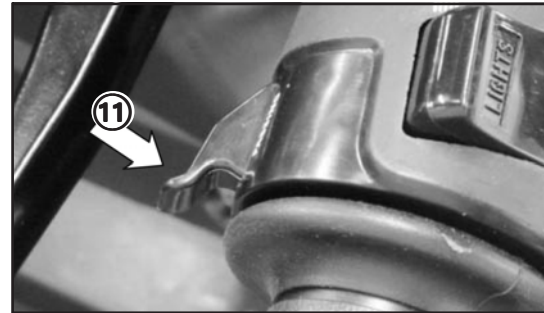

Passing light button:

Use this button ⑪ to rapidly flick the headlamp high beam on and off to signal other vehicles that you wish to pass.

Helmet lock

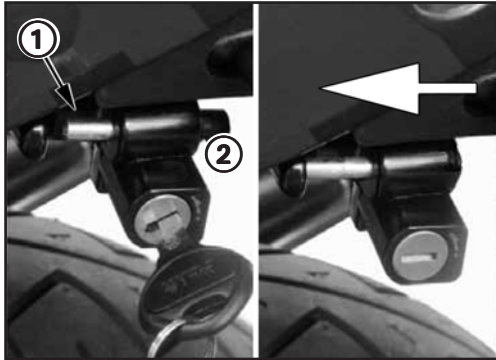

To use the helmet lock:

1. Insert the ignition switch key and rotate it clockwise to open the lock
2. Put the helmet's strap ring into the lock's pin ① and push the outside of the pin ② in to secure the lock.
3. To remove the helmet, use the key to open the lock.

WARNING

Do not ride your motorcycle with a helmet attached to the helmet lock. The lock is not intended to be a helmet holder. A helmet hanging from the lock could interfere with the motorcycle's operation and may cause a loss of control and an accident.

Seat Lock & tool kit

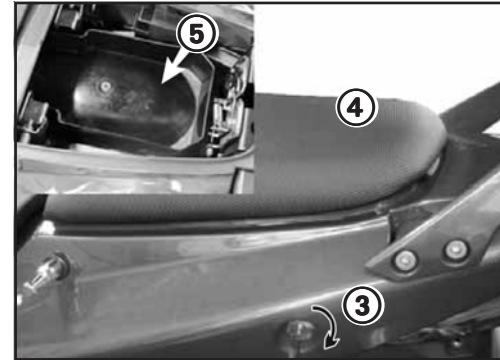

To open the seat (passenger section):

1. Insert the ignition switch key into the seat lock ③ and rotate it clockwise to open the seat latch
2. Lift up on the back edge of the passenger seat ④ and remove it from the motorcycle
3. To replace the seat, engage the hooks on the bottom of the seat with the loops on the frame. Press down on the seat until you hear the seat latch "clicks" indicating it is engaged.

NOTE: Lift gently up on the back of the seat to make sure the seat is secured in the latch.

The tool kit ⑤ is located under the seat in the tray on the top of the fender.

NOTE: The weight capacity of the tool tray is 3.3 lb (1.5 kg).

Multifunction meter display

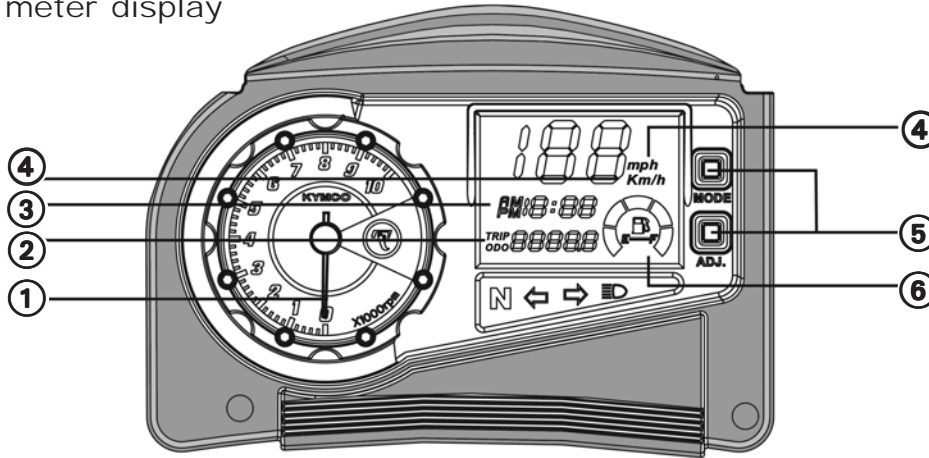

- ① **Tachometer:** Indicates engine revolutions per minute (RPM).
- ② **Odometer / Tripmeter / Oil Service Meter Display:** The odometer displays the vehicle's total operating mileage. The tripmeter displays the amount of mileage since the rider last reset the display to "zero". The oil service meter can be set to alert the rider that oil service is required.
- ③ **Clock:** Displays the time in 12-hour format (AM/PM).
- ④ **Speedometer:** Indicates the vehicle speed in kilometers per hour (Km/h) or in miles per hour (MPH), depending upon the setting chosen by the rider.
- ⑤ **Adjustment buttons:** Used to set the time display on the clock, and to access or clear the tripmeter display.
- ⑥ **Fuel level gauge:** indicates the approximate amount of fuel in the fuel tank. If the gauge indicates "E", the fuel level is low and gasoline must be added.

NOTE: The indicator needle of the tachometer's analog dial will sweep from zero to the maximum reading then back to zero when the ignition switch is turned "ON" (or when the battery is reconnected following service). This is a normal function of this type of meter and is required to calibrate the dial before the engine is operated.

Multifunction meter display

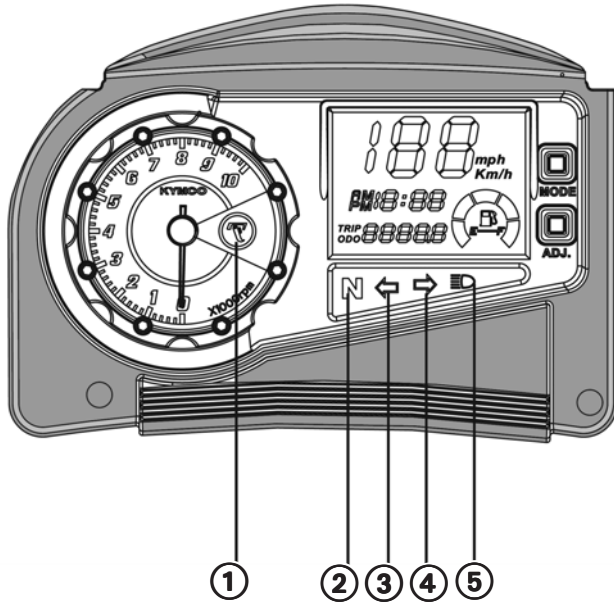

- ① **Side Stand Indicator Light:** Indicates that the motorcycle's side stand is in the "down" position.
- ② **Neutral Position Indicator Light:** Indicates that the motorcycle's transmission is in the "neutral" position. The light will only illuminate if the ignition switch is "ON" and the transmission is in "neutral".
- ③ **Left Turn Signal Indicator Light:** When the turn signal switch on the left handlebar switch is pushed to the left, the left turn signal and this indicator light will flash.
- ④ **Right Turn Signal Indicator Light:** When the turn signal switch on the left handlebar switch is pushed to the right, the right turn signal and this indicator light will flash.
- ⑤ **High Beam Indicator Light:** When the headlight switch on the left handlebar switch is pressed to the "HI" position, the headlight high beam and this indicator will light. The indicator will also light if the passing lamp switch is pressed on the left handlebar switch.

Multifunction meter display

The liquid crystal display (LCD) portion of the multifunction meter has the following functions:

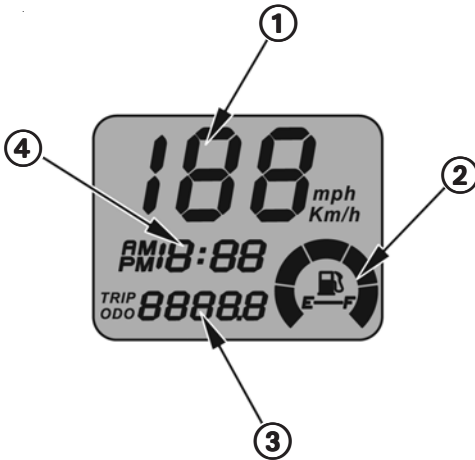

- ① Speedometer
- ② Fuel Level Gauge
- ③ Odometer / Tripmeter / Oil Service Meter
- ④ Digital Clock

Initial display

When the ignition switch is turned "ON", the multifunction display will temporarily display all of the elements for each function so you can be sure that the display is functioning properly.

Speedometer

The speedometer displays the road speed of the motorcycle in MPH or Km/h.

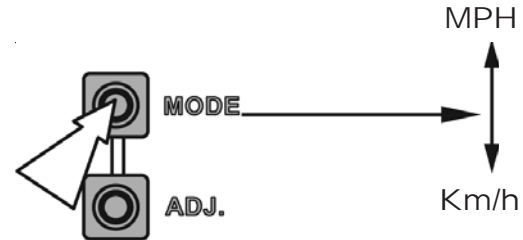

To toggle the speedometer display between MPH or Km/h, press and hold the MODE button for more than two seconds.

See item "⑤" on page 15.

Odometer / Tripmeter / Oil Service meter

To select MPH, Km/h or the oil service reminder display on the LCD panel, press and hold the MODE button for more than two seconds.

See item “⑤” on page 15.

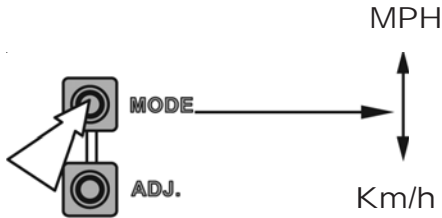

Odometer:

The odometer displays the vehicle's total operating mileage.

Tripmeter:

The tripmeter displays the amount of mileage since the rider last reset the display to "zero".

Oil Service meter:

The oil service meter shows the mileage for oil service frequency. The oil service meter can be set to alert the rider that oil service is required.

To select the Odometer/Tripmeter/Oil Service meter:

1. Press and hold the ADJ. (Adjust) button for more than two seconds to select the odometer, tripmeter or oil service meter display on the LCD.

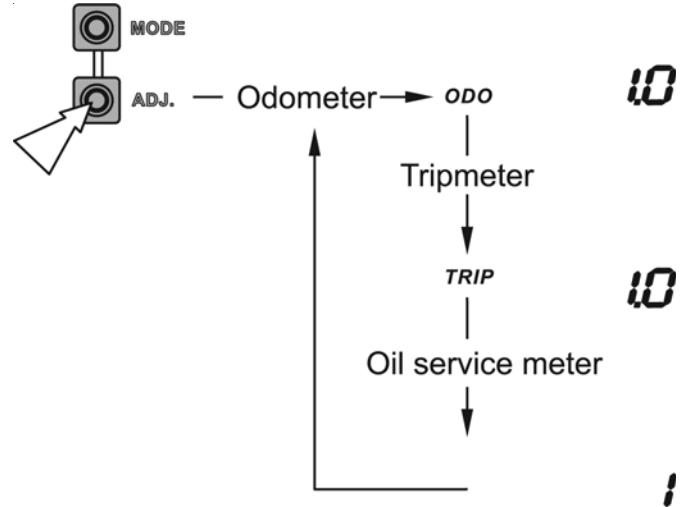

To reset the tripmeter:

1. Press and hold the ADJ. (Adjust) button for more than two seconds to select *TRIP*.

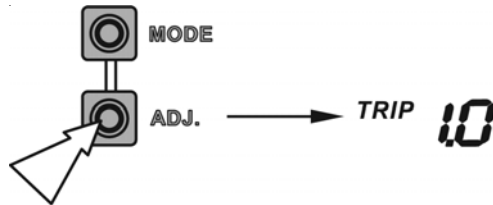

To reset the oil service meter:

1. Press and hold the ADJ. (Adjust) button for more than two seconds to select the oil service meter.

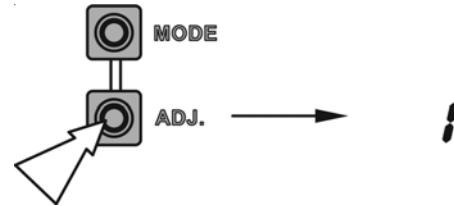

2. Press and hold the MODE and the ADJ. (Adjust) button at the same time until the tripmeter resets to "zero".

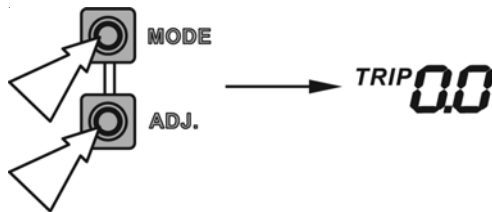

2. Press and hold the MODE and the ADJ. (Adjust) button at the same time until the oil service meter resets to "zero".

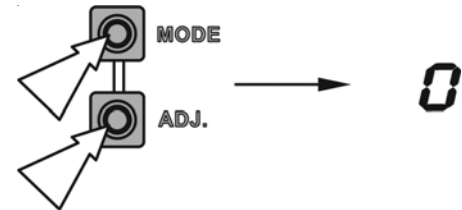

Fuel level gauge

The fuel level gauge shows the approximate fuel supply available via a segmented display on the LCD. The normal operating range of the gauge is between the “E segment” ① and the “F segment” ②. When the “E segment” or the fuel pump icon ③ flashes, the fuel level is low and you should refill the fuel tank as soon as possible.

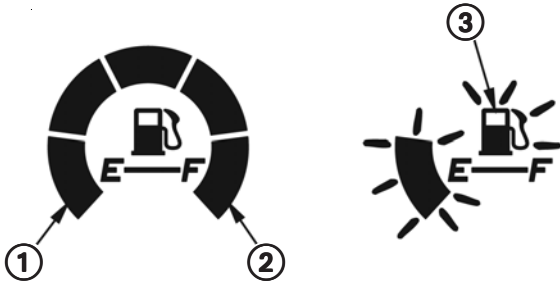

- ① Segment E - indicates “Empty”
- ② Segment F - indicated “Full”
- ③ Fuel pump icon

Digital clock

The clock displays the time (in hours and minutes) when the ignition is ON.

To adjust the clock’s time, follow this procedure:

1. Turn the ignition switch ON.
2. Press and hold the ADJ. (Adjust) button for more than two seconds to select the ODO mode.

NOTE: The digital clock can only be adjusted in the ODO mode. Do not select the tripmeter or oil service meter modes if you wish to adjust the clock’s time display.

3. Press and hold both the MODE and the ADJ. (Adjust) buttons at the same time for more than two seconds. You will know that the clock is in the adjustment mode when the hour display begins to flash.

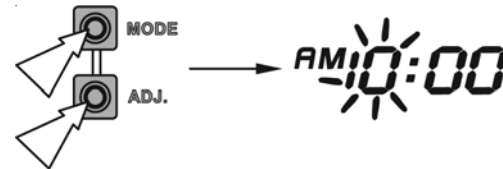

4. To set the hour, press the ADJ. (Adjust) button until the display cycles to the desired hour number.

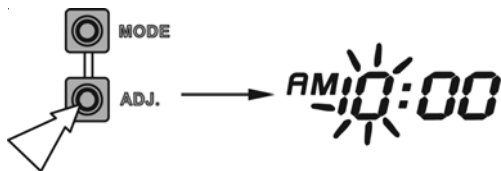

6. To set the minutes, press the ADJ. (Adjust) button until the display cycles to the desired minutes number.

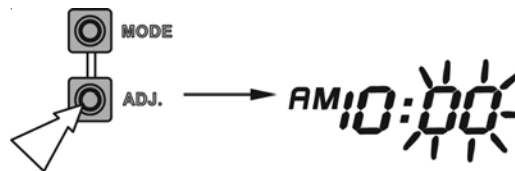

5. Press the MODE button and the minute display will begin to flash.

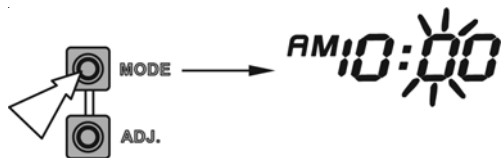

7. To end the clock adjustment, press and hold both the MODE and the ADJ. (Adjust) buttons at the same time. The clock display will stop flashing and any further adjustment will be cancelled if the MODE or the ADJ. (Adjust) button is not pushed within ten seconds.

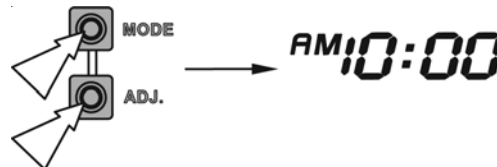

Pre-ride inspection

For your safety, it is very important to take a few moments before each ride to walk around your motorcycle and check its condition. If you detect any problem, be sure to address it immediately, or have it corrected by your KYMCO dealer.

WARNING

Improperly maintaining your motorcycle or failing to correct a problem before riding can cause a crash in which you can be seriously hurt or killed.

Always perform a pre-ride inspection before every ride and correct any problems.

CAUTION

To prolong the service life of your motorcycle, be sure to have a an initial service performed on your motorcycle after it has been ridden for 300 miles (500km).

1. Engine oil inspection: Add engine oil if required (page 23).
2. Front and rear brakes: Check lever operation and free-play, and check the condition of the brake pads (page 24).
3. Tires: Check condition and inflation pressure (page 25).
4. Fuel level: Fill fuel tank when necessary (page 26).
5. Steering: Check for condition and smoothness (page 27).
6. Lights and horn: Check that headlight, tail/brake light, turn signals and horn function properly (pages 27 & 28).
7. Drive chain: Inspect condition and adjustment (page 28).
8. Clutch lever: Inspect free play adjustment (page 29).
9. Throttle: Check for smooth operation and that the throttle closes completely in all steering positions (page 30).
10. Chassis inspection: Perform general inspection to rear suspension, brakes, rear view mirrors, license plate and other chassis items (pages 30 & 31).

NOTE:

Refer to the break-in recommendations on pages 39 and 40 of this manual before riding your motorcycle for the first time.

Engine oil inspection

Check the oil level each time you ride your motorcycle.

1. Place your motorcycle on its center stand (on level ground).



2. Check the oil level at the oil level window in the right engine cover.

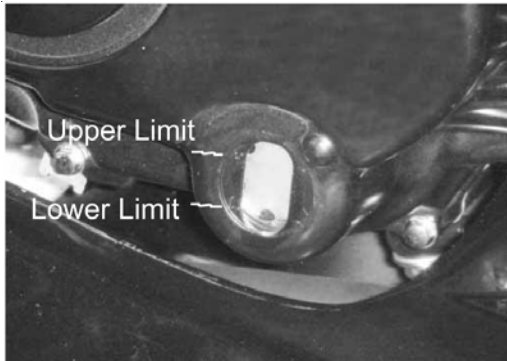

3. Verify that the oil level is between the "upper limit" and the "lower limit" in the window.
4. If the oil level is below the "lower limit", add engine oil until the oil level rises to the "upper limit".

Specified Oil Type:	SAE 15W-40
API Rating:	SJ (or greater)
Oil Capacity:	1.30 qt (1.2L)
Oil Capacity (during oil change):	0.95 qt (0.9L)

WARNING

The engine and exhaust can become very hot after use. Be very careful when inspecting the engine oil level so you do not burn yourself.

CAUTION

Use a motor oil that has been formulated for use in a four-stroke motorcycle engine. Automotive oils will not meet your motorcycle's requirements and can cause premature wear of the engine components. Contact your KYMCO dealer if you have any oil-related service questions or needs.

Brake inspection

Ride your motorcycle at low speed on a dry road and alternately apply the front and rear brakes to check their performance.

The front and rear brake levers should have the proper free play. "Free play" is the distance the lever can move from an at-rest position until the brake mechanism engages when pressure is applied to the brake lever.

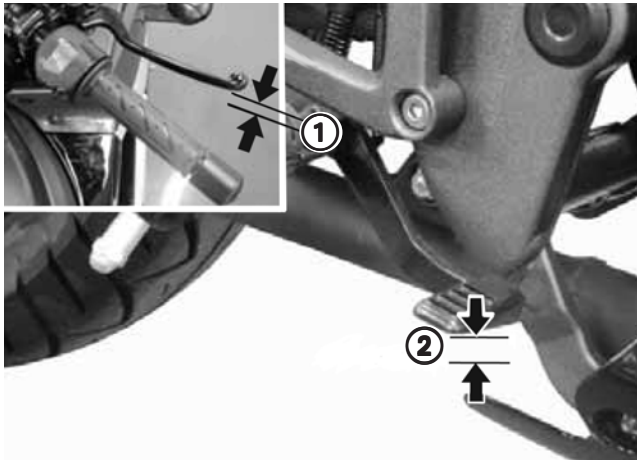

1. Measure the free play of the front brake lever end ① and the rear brake lever ②.

Brake lever play: 0.4 - 0.8 in (10 - 20mm)

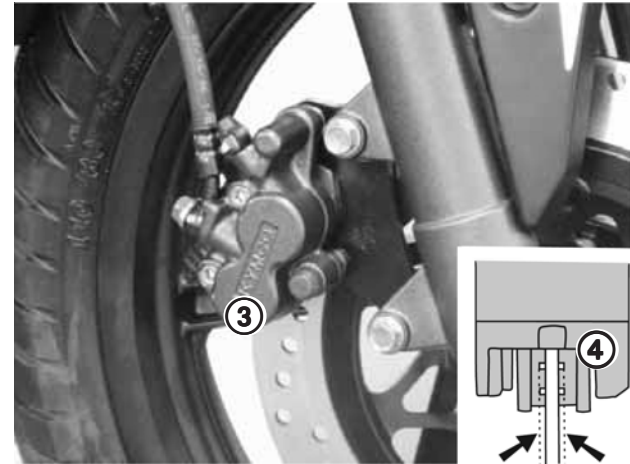

3. Inspect the brake master cylinders, hoses and brake callipers ③ for any fluid leaks.
4. Inspect the brake pads to make sure there is adequate material left ④. If the pad wears to the point that the grooves on the pad disappears, replace both pads immediately.

WARNING

Proper brake operation is essential for your riding safety. Contact your KYMCO dealer immediately if you have any brake-related service needs.

Tire inspection

Inspect the tire inflation pressure and the tire's condition before each ride.

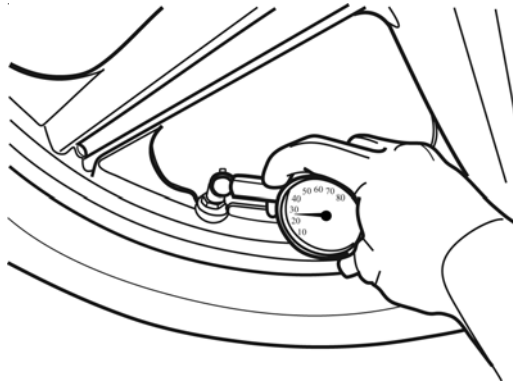

Tire pressure

1. Use a quality tire pressure gauge to check the tire pressure before riding. Check the pressure when the tires are cold.
2. Check the pressure when the motorcycle is at rest on its stand and the tires are touching the ground.
3. Adjust the tire pressure to the specified amounts.

Front tire pressure (rider only): 25 psi (1.75 kg/cm²)

Front tire pressure (rider & passenger): 25 psi (1.75 kg/cm²)

Rear tire pressure (rider only): 28 psi (2.0 kg/cm²)

Rear tire pressure (rider & passenger): 33 psi (2.5 kg/cm²)

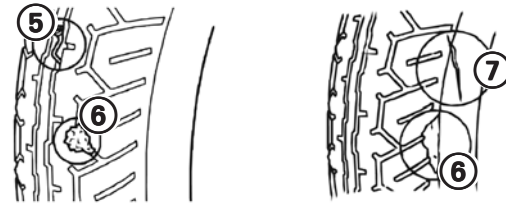

Tire condition

1. Inspect the tire tread for foreign objects (5) (such as a nails, glass, gravel or other embedded objects). Check for other damage (6) in the tire tread area or cracks in the tire sidewall area (7).

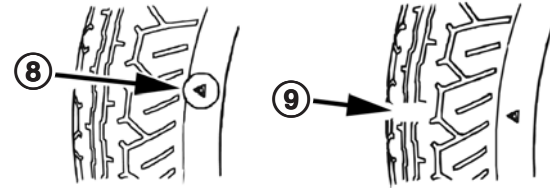

2. Use the indicator arrows (8) on the tire sidewall to locate the wear indicator bars in the tire's tread. As the tire wears, the grooves at the wear indicator bar (9) will disappear, indicating the tire requires immediate replacement.

WARNING

Proper tire inflation and condition is essential for your riding safety. Contact your KYMCO dealer immediately if you have any tire-related service needs.

Fuel level inspection/refilling

If the low fuel level indicator on the dash begins to flash, refill the fuel tank with unleaded gasoline as soon as possible.

Refilling the fuel tank

1. Open the cap lock protective cover on the gas cap. Insert the ignition key ① into the cap lock and rotate the key counterclockwise to unlock the cap. Lift it from the fuel tank to add unleaded gasoline of the specified type into the tank.
2. To replace the cap, align the tab ② on the cap with the groove ③ in the tank's filler neck.
3. Press down on the cap until you sense the tab "clicking into place". This indicates that the cap has been properly secured to the tank. Remove the key ④ from the cap.

Fuel recommendation

Use unleaded gasoline with a research octane number of 91 or higher. Unleaded gasoline will extend spark plug life.

WARNING

Gasoline is highly flammable and explosive. You can be burned or seriously injured while handling fuel.

- * Stop the engine and keep heat, sparks, and flame away.
- * Refuel only out doors.
- * Clean up fuel spills immediately.

Do not overfill the tank. There should be no fuel in the filler neck. Excess fuel can contaminate the evaporative emission canister, resulting in poor driveability.

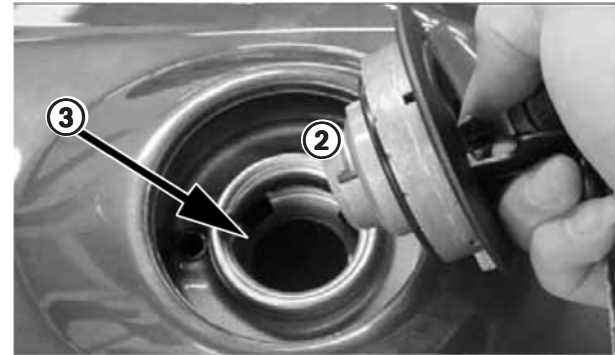
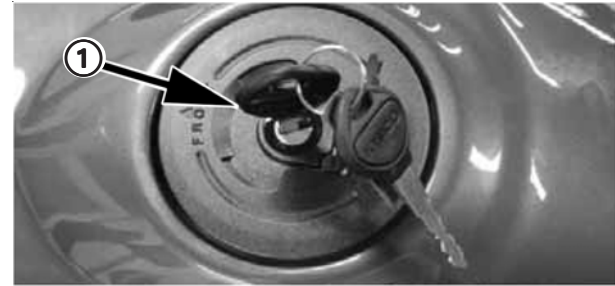

Steering inspection

Before each ride, inspect the handlebars and steering on your motorcycle.

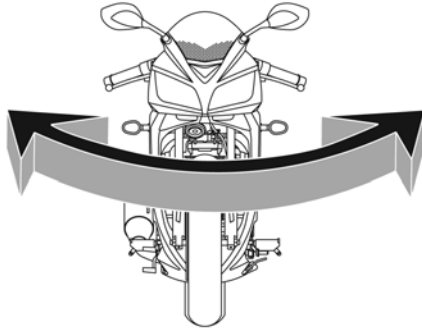

1. Visually inspect the handlebars for damage.
2. Grasp the front brake and push the suspension up and down, listening for any abnormal noise.
3. Move the handlebar upwards, downwards, and to left and right to check for any loose or restricted movement.
4. Make sure that the steering moves freely through its full range of motion from full left to full right.

WARNING

Proper handlebar, steering component, and front suspension action is essential for your riding safety. Contact your KYMCO dealer immediately if you have any steering or suspension-related service needs.

Lights & horn inspection

Before each ride, check the light and horn operation on your motorcycle.

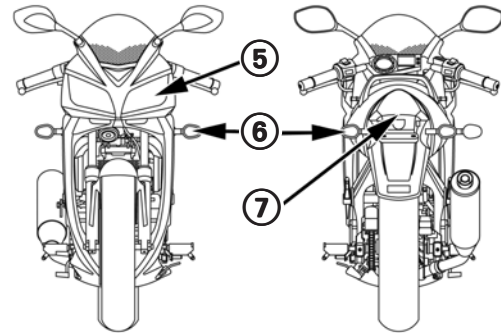

Headlight/taillight inspection

Start the engine to make sure the headlights ⑤ and the taillight ⑦ illuminate. Check the lens for damage, dirt or moisture condensation.

Turnsignal inspection

Operate the turn signal rocker switch on the left handlebar controls to make sure that both the left and right turn signals ⑥ illuminate and flash. Check the lens for damage, dirt or moisture condensation.

Stoplight inspection

Squeeze the front brake lever, and then press down on the rear brake lever to make sure the stoplight in the taillight ⑦ illuminates.

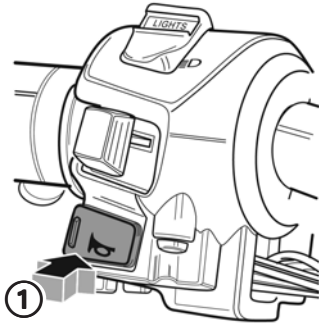

Horn inspection

1. Press the horn button ① on the left handlebar control to confirm that the horn sounds and it has adequate volume.

⚠ WARNING

Proper light and horn function is essential for your riding safety. So you can properly see the road, and others can see you, replace any failed bulbs immediately. Clean or replace any damaged or dirty lenses immediately. If your horn fails to operate, or the sound is weak, have it adjusted or replaced. Contact your KYMCO dealer immediately if you have any lights or horn-related service needs.

Drive chain inspection

Before each ride, check the drive chain on your motorcycle.

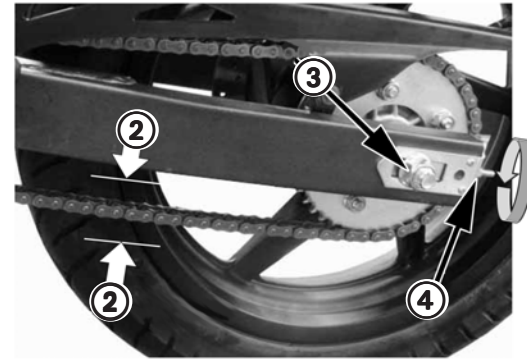

1. Check the drive chain slack ② and confirm that it is not too loose or is too tight.

Drive chain slack: 0.4 - 0.8 in (10 - 20mm)

2. To adjust the chain slack, loosen the rear axle nut ③.
3. Turn the adjuster nuts ④ in equal increments at the back of the swingarm until the proper amount of drive chain slack is achieved. Use the punch marks stamped into the swingarm for reference while adjusting the slack. Once the proper slack is set, tighten the axle nut.

⚠ CAUTION

Improper drive chain slack adjustment will cause premature chain wear. Clean the drive chain with kerosene. To prevent premature wear and rust, use a chain lubricant approved for use on O-ring type drive chains.

Clutch lever & cable inspection

Before each ride, check the clutch lever free play and operation on your motorcycle.

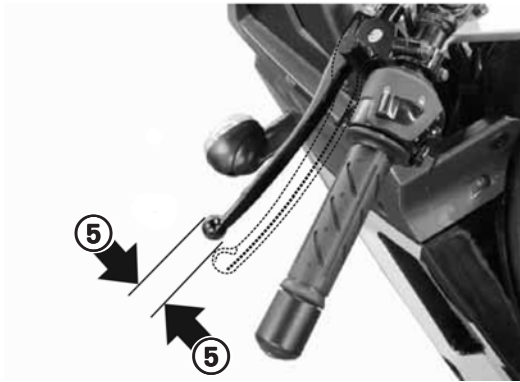

Clutch lever free play inspection

1. Check the lever's free play **⑤** and make the free play fall within the specified range. If not, follow the adjustment procedures listed here.

Clutch lever free play: 0.2 - 0.4 in (5 - 10 mm)

2. Make sure that the clutch cable action is smooth as you squeeze the clutch lever. If not, lubricate the clutch cable and readjust the free play.

⚠ CAUTION

Improper clutch lever and cable free play adjustment will cause premature clutch wear. Lubricate and adjust the clutch control often to prevent failures.

Clutch cable free play adjustment

1. Loosen the lock nut **⑥** on the clutch lever perch and turn the adjuster nut **⑦** clockwise until it is seated to the perch.

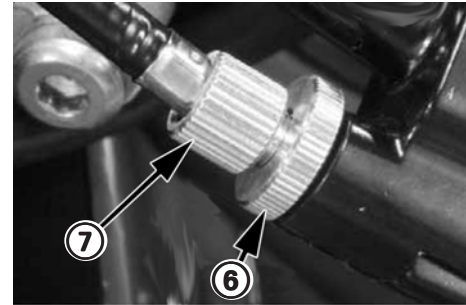

2. Loosen the cable lock nut **⑧** and rotate the adjuster nut **⑨** until you achieve the proper clutch lever free play. Tighten the adjuster nut **⑨**.

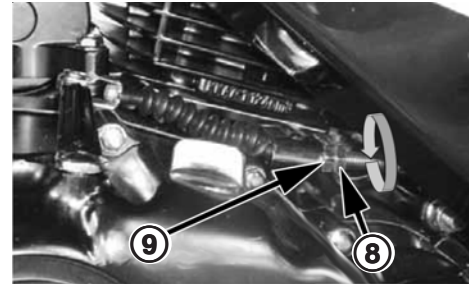

3. Make any fine adjustments in the clutch lever free play using the adjuster **⑦** on the clutch lever perch. Once the free play is set, tighten the adjuster nut **⑥**.

Throttle inspection

Before each ride, make sure that the throttle returns to its fully closed position at all steering angles.

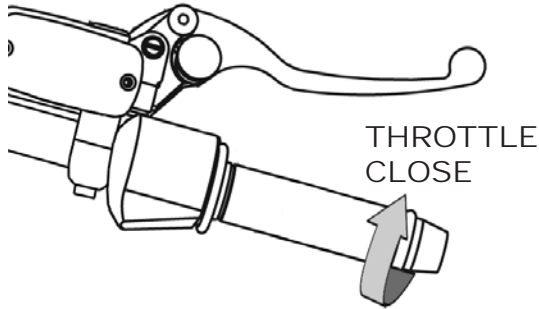

WARNING

Proper throttle operation is essential for your riding safety. Do not ride your motorcycle if the throttle does not operate smoothly or fails to close fully when released. Contact your KYMCO dealer immediately if you have any throttle-related service needs.

Chassis inspection

Before each ride, check the operation and condition of other components on your motorcycle's chassis.



Rear suspension inspection

Press down on the seat several times to make sure the rear suspension action is smooth. Visually inspect the rear damper for fluid leaks.

Brake performance inspection

Press down on the rear brake pedal and squeeze the front brake lever to verify that the brakes prevent the wheels from turning. Visually inspect the brake components for fluid leaks.

Rear view mirror inspection

Adjust the mirrors so you have a clear rear view. Make sure the mirrors are secured to the fairing so they will not vibrate excessively and cause difficulty seeing the using the mirrors.

License plate inspection

Make sure the license plate is secure on the motorcycle and is in plain view. Make sure any other required inspection labels or tags are positioned as required by law.

Damaged items or needed repairs

Should you discover any damage to your motorcycle, or that the motorcycle is in need of repair, take action to have it serviced immediately. Keeping your motorcycle in proper working condition is essential for your safety and for maintaining the value of your vehicle.

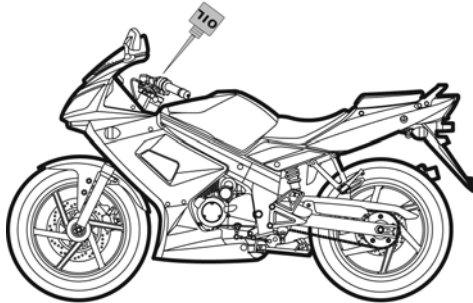

Lubrication point check

Visually check that all of the motorcycle's lubrication points have been lubricated properly.

Starting the engine

Always follow the proper starting procedure as described here.

NOTE: Your motorcycle is equipped with a side stand ignition cutoff system. The engine cannot be started if the side stand is down. A running engine will shut off if the side stand is lowered.

WARNING

Your motorcycle's exhaust emits poisonous carbon monoxide gas. High levels of carbon monoxide can collect rapidly in enclosed areas such as a garage. Do not run the motorcycle's engine with the garage door closed. Even with the door open, run the engine only long enough to move your motorcycle out of the garage.

CAUTION

To prevent damage to the starter motor, do not operate the starter motor for more than five seconds at a time. If the motorcycle fails to start immediately, check the fuel level and the battery condition, and allow the starter motor to cool before attempting to start the engine again.

NOTE: Always check the engine oil level and the fuel level **BEFORE** attempting to start your motorcycle's engine.

Starting - When the engine is cold

1. Use the ignition key to unlock the steering lock on the steering head.

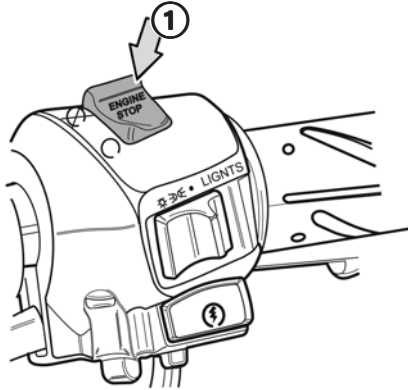

2. Make sure the engine stop switch (1) is "ON".

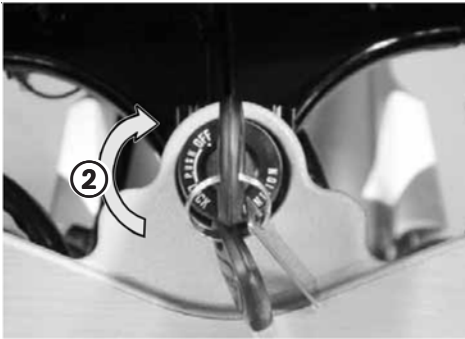

3. Turn the ignition switch (2) to "ON".

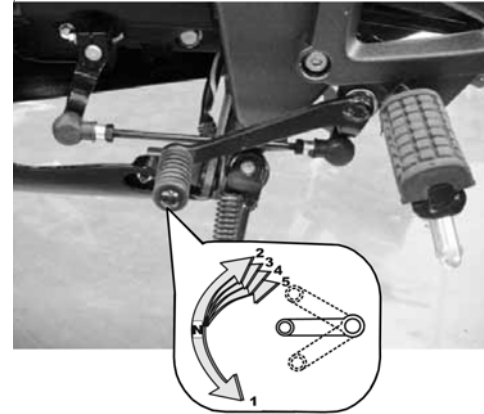

4. The engine must be started with the transmission in the neutral position. When the transmission is in "NEUTRAL" the neutral indicator on the dash will illuminate.

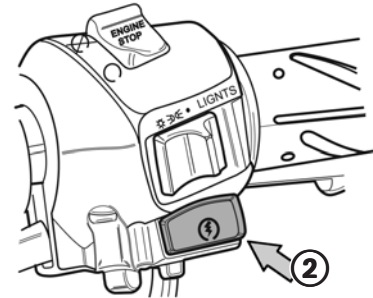

5. With the throttle closed, squeeze the clutch lever and press the starter button (2). Release the starter button as soon as the engine starts.

NOTE: The low oil pressure indicator on the dash should go off within a few seconds of starting the engine. If the light stays on, stop the engine immediately and check the engine oil level.

⚠ CAUTION

Operating your motorcycle's engine with insufficient oil pressure can cause serious engine damage.

6. Release the clutch lever and keep the throttle closed while the engine warms up. Allow the engine to warm until the idle speed is stable and smooth.

⚠ CAUTION

Do not press the starter button while the engine is running, as the engine will be damaged.

Starting - When the engine is warm

Starting a warm engine is the same as starting a cold engine, except that the throttle must be held partially open during starting.

1. Follow steps 1 through 4.
2. Rotate the throttle grip open 1/8 to 1/4 open, squeeze the clutch lever and press the starter button ②. Release the starter button as soon as the engine starts.
3. Follow step 6, being careful to adhere to the caution and warning notes.

Riding the motorcycle

Before each ride, follow the pre-ride inspection guidelines listed on pages 22 through 31 of this manual.

1. Start the engine following the procedures on pages 31 through 33 of this manual.

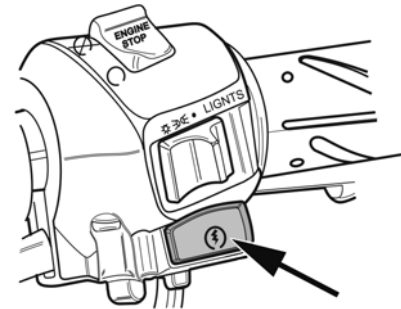

⚠ CAUTION

Do not press the starter button ③ while the engine is running, as the engine will be damaged. Keep the transmission in neutral while the engine warms up.

NOTE: After starting the engine, allow time for the engine oil to circulate before riding your motorcycle. Allow sufficient idling time after warm or cold engine start up before applying load or revving the engine. This allows time for the lubricating oil to reach all critical engine components.

NOTE: Review all of the safety recommendations that are listed in this manual before you ride.

⚠ WARNING

Wear a helmet and other safety equipment as recommended in this Owner's Manual.

Mount the motorcycle from the left side and firmly grasp the handlebars with both hands. Once you are seated, sit upright and touch the ground with both feet to prevent slipping. Retract the side stand and ride off to begin your ride.

Make sure that the throttle is closed before moving the motorcycle off of its stand.

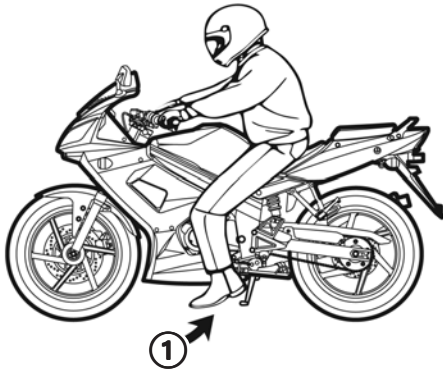

2. Retract the side stand ①.

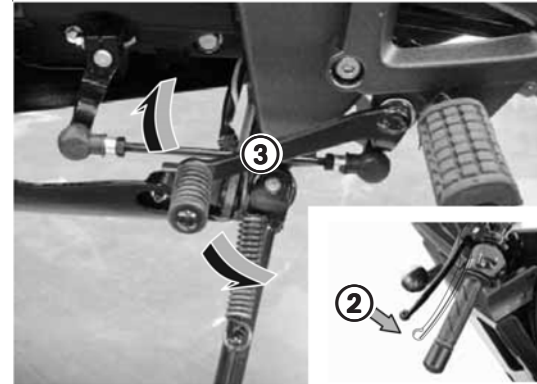

3. Squeeze the clutch lever ②, and press down on the shift lever ③ with your left foot, to move the transmission from "NEUTRAL" into first gear.

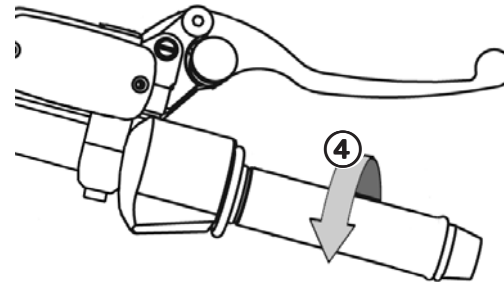

4. Slowly rotate the throttle grip ④ while simultaneously releasing the clutch lever. The motorcycle will begin to move forward.

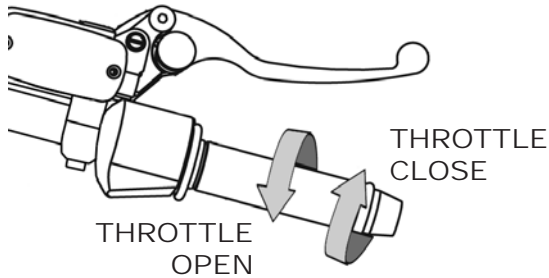

⚠ CAUTION

The throttle grip must be returned to the fully closed position each time you shift. Squeeze the clutch lever and press down or lift up with your left foot to shift the transmission.

- Before moving into traffic, indicate your intended direction with your turn signals, and check the conditions to see if it is safe to proceed.

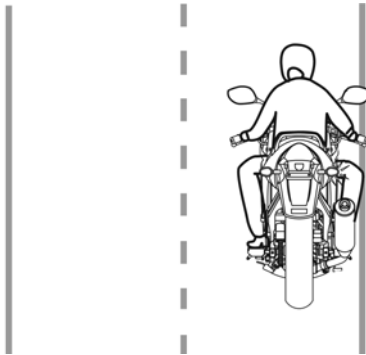

⚠ CAUTION

Moderate riding habits will prolong the service life of your motorcycle. Aggressive riding will prematurely wear items such as the clutch and the brake pads. During the first 600 miles of riding, keep your road speed below 50 MPH to allow the engine to break in fully, so it will perform properly in the future.

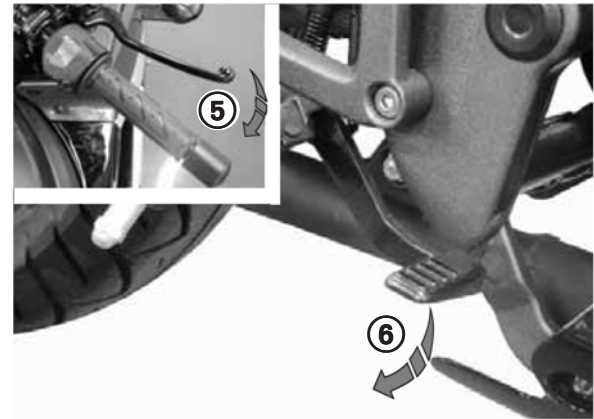

- You must coordinate your use of the throttle, and the front ⑤ and rear ⑥ brakes in order to safely decrease your motorcycle's speed as you ride. Both the front and rear brakes should be applied simultaneously. Independent use of only the front or rear brake reduces stopping performance.

 **WARNING**

Excessive braking can cause either wheel to lock, and could result in your losing control of your motorcycle. Use moderation when first applying the brakes, increasing brake lever pressure smoothly and evenly to increase the braking performance. Avoid continuous use of the brakes, which may result in overheating and reduction of the braking system's efficiency.



7. When approaching a corner or turn, close the throttle fully and slow the motorcycle down by simultaneously applying both the front and rear brakes.
8. After completing the turn, open the throttle gradually to accelerate the motorcycle.
9. When descending a steep grade, close the throttle fully and apply both brakes to slow the motorcycle.

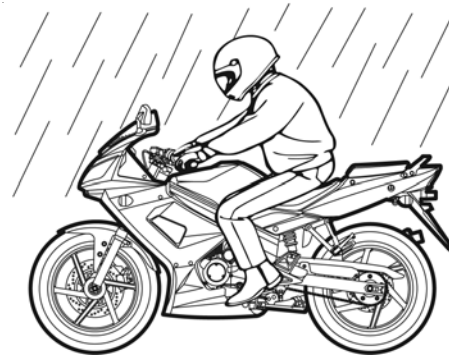

10. When riding your motorcycle on wet or slippery surfaces, be especially cautious.

 **WARNING**

When riding in wet or rainy conditions or on slippery surfaces, your ability to maneuver and stop will be reduced. For your safety:

- Exercise extreme caution when braking, accelerating or turning.
- Ride at slower speeds and allow for extra stopping time and distance.
- Keep the motorcycle as upright as possible.
- Use extreme caution when riding over slippery surfaces such as railroad tracks, iron plates, manhole covers, and painted lines.

Stopping & parking the motorcycle

Use care when concluding your ride and parking your motorcycle.

1. To alert other drivers in plenty of time, use your turn signal in advance of your intended turn.
2. Use your mirrors and turn your head in order to see other vehicles that are to your side or behind you.

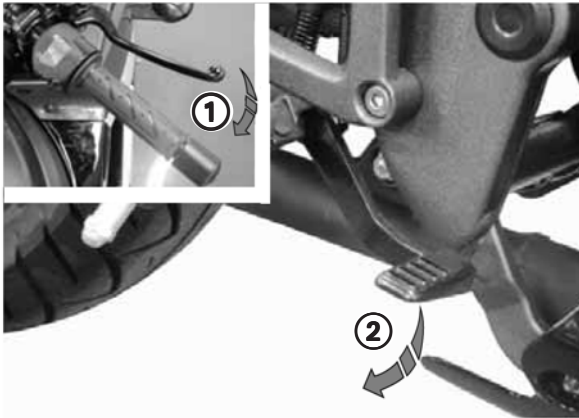

3. Reduce your speed by closing the throttle and then apply both the front ① brake and rear ② brakes evenly and smoothly. As you brake, the motorcycle's brake light will illuminate.
4. Remember to return the turn signal switch to the center (off) position after completing your stop.

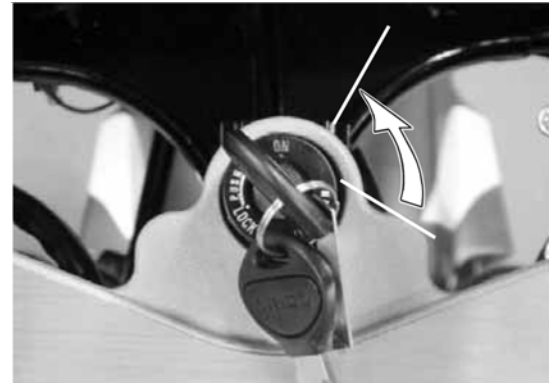

5. After you have come to a full stop, turn the ignition switch to the "OFF" position.

WARNING

Never operate the ignition switch while riding. Doing so will result in a sudden loss of power to your motorcycle and could cause you to lose control. Only operate the ignition switch after the motorcycle has come to a complete and safe stop.

CAUTION

Always park your the motorcycle on firm, level ground to help prevent it from falling over.

If you must park on an incline, aim the front of your motorcycle uphill, and place it on the center stand.

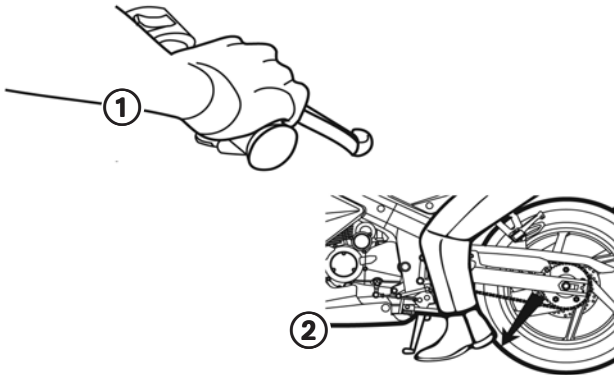

6. Squeeze the front brake lever ①, flip the side stand down ② and dismount the motorcycle from the left side.



7. Turn the handlebars to the left and rotate the ignition key in the ignition switch to lock the steering. Remove the key.

8. Verify that your motorcycle is parked safely and that it will not tip over.

WARNING

The exhaust pipe and muffler become very hot during operation and remain so for some time after stopping. Be careful that you or others do not come into contact with these parts of the motorcycle when you first stop the motorcycle, and for enough time thereafter to allow these parts to cool. Touching these parts before they have cooled can result in serious burns.

Park your motorcycle where pedestrians or children are not likely to touch the muffler.

Make sure flammable materials such as dry grass or leaves do not come in contact with the exhaust system when parking your motorcycle.

Break-in recommendations

The first 1000 miles (1600 km) of riding are the most important in the life of your motorcycle. Proper break-in operation during this time will help ensure maximum life and performance from your new motorcycle. Proper break-in operation allows the machined surfaces to polish each other and mate smoothly.

Your motorcycle's reliability and performance depend on special care and restraint exercised during the break-in period. It is especially important that you avoid operating the engine in a manner which could expose the engine parts to excessive heat.

The following guidelines should be followed during the break-in period:

Maximum throttle operation:

Initial 500 miles (800 km): Less than 1/2 throttle

Up to 1000 miles (1600 km): Less than 3/4 throttle

Vary the engine speed:

The engine speed should be varied and not held at a constant rate for long periods of time. This allows the parts to be "loaded" with pressure, and then unloaded, allowing the parts to cool. This aids in the mating process of the engine and transmission components. It is essential that some stress be placed on these components during break-in to ensure this mating process. Do not, however, apply excessive load on the motorcycle's drive line.

Avoid constant low speed:

Operating the engine at constant low speed (light load) can cause parts to glaze and not seat in properly. Allow the engine to accelerate freely through the gears, without exceeding the recommended throttle openings.

Avoid using full throttle for the first 1600 km (1000 miles).

The initial service:

Observe your first and most critical service The 300 mile (500 km) initial service is the most important service your motorcycle will receive. During the break-in period all of the engine components will have worn in, and all of the other parts will have seated in, so adjustments will be required. All fasteners will be tightened, and the contaminated engine oil will be replaced.

NOTE: Completion of the 300 mile (500 km) initial service will ensure optimum service life and performance from your motorcycle. Do not delay in having this service performed once your motorcycle reaches this mileage.

⚠ CAUTION

The 300 mile (500 km) service should be performed as outlined in the maintenance schedule section of this Owner's Manual. Pay particular attention to the caution and warning in maintenance schedule section.

Unless you have formal training as a service technician, and have access to KYMCO technical reference materials, it is strongly suggested that you have the initial service performed by a KYMCO dealer.

Breaking in the new tires

New tires need proper break-in to assure maximum performance, just as your motorcycle's engine does. Scuff in the tires' tread surface by gradually increasing your cornering lean angles over the first 100 miles (160 km) before attempting maximum lean angles. Avoid hard acceleration, hard cornering, and hard braking for the first 100 miles (160 km).

⚠ WARNING

Failure to break in your tires could cause the tires to slip and could result in you losing control of the motorcycle.

Use extra care when riding on new tires. Ride your motorcycle properly and safely as described in this Owner's Manual and avoid hard acceleration, hard cornering, and hard braking for the first 100 miles (160 km).

SECTION 4 - MAINTENANCE



The importance of maintenance
Maintaining your motorcycle properly is essential for safe, economical and trouble-free riding. It will also help reduce air pollution and maximize fuel economy.

To help you properly care for your motorcycle, the following pages in this Owner's Manual include a maintenance schedule to help you make sure your motorcycle is serviced at the appropriate intervals.

These instructions are based on the assumption that your motorcycle will be used exclusively for its designed purpose. Sustained high speed operation or operation in unusually wet or dusty conditions will require more frequent service than specified in the maintenance schedule. Consult your KYMCO dealer for recommendations applicable to your individual needs and use.

NOTE: Always follow the inspection and maintenance recommendations and schedules in this Owner's Manual.

WARNING

If your motorcycle tips over or becomes involved in a crash, be sure your KYMCO dealer inspects all major parts, even if you are able to make some repairs.

Improperly maintaining this motorcycle or failing to correct a problem before you ride, could result in a crash in which you could be seriously hurt or killed.

WARNING

When performing maintenance on your motorcycle you may need to start the engine. Running your motorcycle's engine indoors, or in a garage, can be hazardous. Exhaust gas contains carbon monoxide, a gas that is colorless and odorless, and can cause death or severe injury. Operate the engine only where there is adequate ventilation, preferably outdoors.

Maintenance schedule

Perform the pre-ride inspection (see page 22) at each scheduled maintenance period. This interval should be judged by the odometer reading.

Maintenance schedule legend (see page 43):

I: INSPECT AND CLEAN, ADJUST, LUBRICATE OR REPLACE IF NECESSARY

C: CLEAN R: REPLACE A: ADJUST L: LUBRICATE

The maintenance schedule on the opposite page specifies the maintenance required to keep your Quannon motorcycle in peak operating condition. Maintenance work should be performed in accordance with KYMCO standards and specifications by properly trained and equipped technicians. Your KYMCO dealer meets all of these requirements.

* Should be serviced by your KYMCO dealer, unless you have the proper tools, service data, and are technically qualified.

** In the interest of safety, we recommend these items be serviced only by your KYMCO dealer.

KYMCO USA recommends that your KYMCO dealer road test your motorcycle after each periodic maintenance service is completed.

Maintenance schedule notes (see page 43):

1. At higher odometer readings, repeat at the frequency interval established here.
2. Service more frequently if the motorcycle is ridden in unusually wet or dusty areas.
3. Service more frequently when riding in rain or at full throttle.

Maintenance schedule

Item	Regular Service Mileage								Daily Pre-ride Inspection
	300 mi	600 mi	1800 mi	3000 mi	4200 mi	5400 mi	6600 mi	7800 mi	
	500 km	1000 km	3000 km	5000 km	7000 km	9000 km	11000 km	13000 km	
✓ Engine Oil	R	R	R	R	R	R	R	R	I
✓ Engine Oil Strainer	C		C		C		C		
✓ Spark Plug	• Clean (C) at every 2000km and replace (R) at every 5000 km.								
✓ Valve Clearance	A		A		A		A		
✓ Carburetor			I		I		I		
✓ Drive Chain		A	A	A	A	A	A	A	I
✓ Air Cleaner		I	R	I	R	I	R	I	
✓ Battery Electrolyte		I	I	I	I	I	I	I	I
✓ Fuel Filter Screen					R				
✓ Brake System		I	I	I	I	I	I	I	I
✓ Clutch Lever Free Play	A		A	A	A	A	A	A	I
✓ Bolts & Nuts	T			T			T		
✓ Tire Pressure		I	I	I	I	I	I	I	I

The above items are applicable to different models. Perform suitable items for each model.
 When exceeding the listed mileage, perform maintenance according to the listed intervals.
 The air cleaner requires more frequent cleaning or replacing when ridden in unusually dusty areas.

MAINTENANCE

Engine oil

Engine oil recommendation

Use a premium quality 4-stroke engine oil to ensure longer service life of your motorcycle. Only use oils that have been formulated for use in a motorcycle, and have a SJ rating per the API service classification.

Specified Oil Type:	SAE 15W-40
API Rating:	SJ (or greater)
Oil Capacity:	1.30 qt (1.2L)
Oil Capacity (during oil change):	0.95 qt (0.9L)

If this viscosity is not available, select an alternative engine oil, according to the chart shown below.

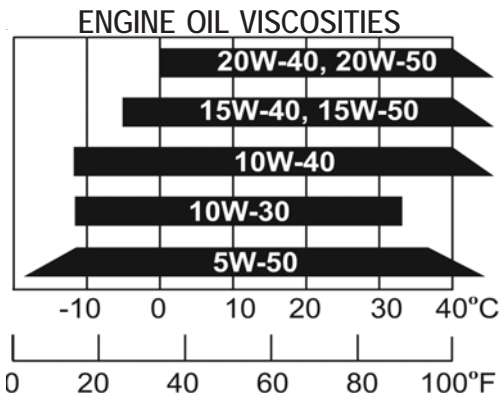

NOTE: Contact your KYMCO dealer for engine oil screen service.

Engine oil change

Engine oil quality is the primary factor that affects engine longevity. Change your motorcycle's engine oil as specified in the maintenance schedule (see pages 42 and 43).

NOTE: When riding your motorcycle in very dusty conditions, oil changes should be performed more frequently than specified in the maintenance schedule.

NOTE: Always dispose of used engine oil in an environmentally responsible manner. You should take the drain oil in a sealed container to your local recycling center or service station for reclamation. Do not throw the oil in the trash, pour it on the ground, or pour it down a drain.

NOTE: Change the engine oil with the engine at normal operating temperature, and the motorcycle on its center stand (or suitable service lift) to assure complete and rapid draining.

⚠ WARNING

The engine and related components can become very hot. Use care when inspecting the oil level so you do not burn yourself. If needed, let the engine and exhaust system cool before working in those areas.

Prolonged contact with used engine oil can cause skin cancer. Although rare, this possibility exists if you handle oil on a frequent basis. Thoroughly wash your hands with soap and water as soon as possible after handling used oil.

MAINTENANCE

1. Start the engine and let it idle for a few minutes. Make sure the red low oil pressure indicator goes off. If the light remains on, stop the engine immediately.

⚠ CAUTION

Running the engine with insufficient oil pressure can cause serious engine damage.

2. Stop the engine and put the motorcycle on its center stand (or a suitable service lift) on level ground.

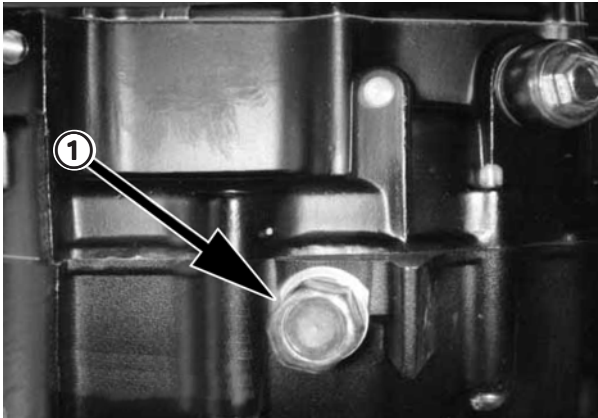

3. Remove the oil drain bolt (1), and drain the engine oil into a suitable container.
4. Reinstall the drain plug, and tighten it to the specified torque.

Oil drain plug torque: 18 lb-ft (25 N-m)

5. Remove the oil filler cap. Add oil to the engine per the specified amount, and reinstall the oil filler cap.

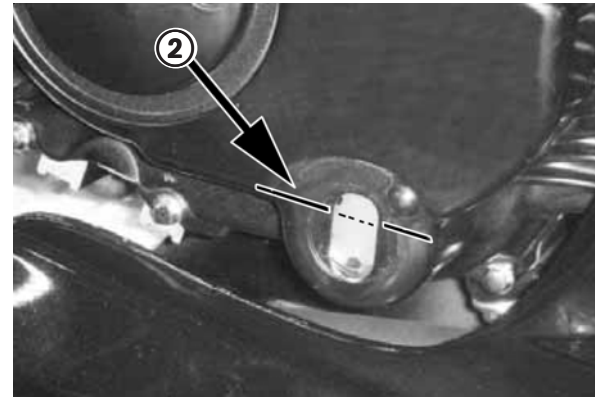

6. Verify that the oil level reaches the upper mark in the oil level window (2).
7. Start the engine and let it idle for 2 - 3 minutes.
8. Stop the engine and check the oil level in the oil level window, on the right engine cover (with the motorcycle parked on the center stand, on level ground).
9. Adjust the oil level as required (so the level reaches the upper mark in the oil level window (2)). Replace the oil filler cap and inspect for any leaks.

Spark plug

The spark plug should be inspected, cleaned and replaced periodically. Whenever servicing the spark plug ①, be sure to observe the color of the removed spark plug's porcelain tip.

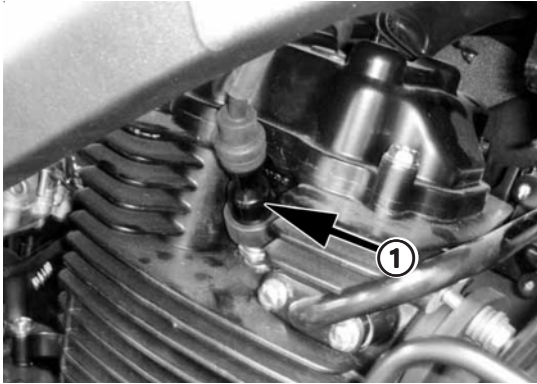

This color tells you whether or not the standard spark plug is suitable for your type of riding. Under normal usage, a spark plug's porcelain tip should be light brown or tan color. If the spark plug porcelain tip is very white or glazed appearing, then the spark plug has been operating too hot. In such a situation, you should replace the standard spark plug with a spark plug that has a colder heat range (usually a higher number; consult with your KYMCO dealer when selecting an alternate spark plug).

Recommended spark plug

Quannon 150 models:	CR8E
Spark plug gap:	0.024 - 0.028 in (0.6 - 0.7 mm)

⚠ CAUTION

An improper spark plug may have an incorrect fit or heat range for your motorcycle's engine. This may cause severe engine damage, which will not be covered under warranty. Never use a spark plug with an improper heat range, as severe engine damage could result.

Spark plug service & replacement:

1. Remove the spark plug with a suitable spark plug socket
2. Inspect the spark plug for cracks in the porcelain insulator, damage to the main threads, and for worn, fouled or carbonized ground electrode.

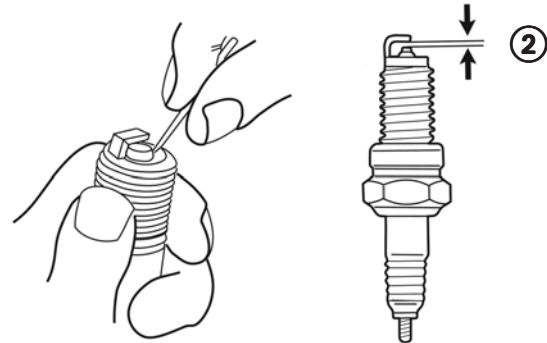

3. If the spark plug has only been removed once it is acceptable to reuse (removal and reinstallation more than two times will compromise the sealing washer's ability to seal combustion chamber gases).
4. Remove the carbon deposits from the spark plug with a small wire brush or a spark plug cleaning machine. After cleaning (or when installing a new spark plug), readjust the spark plug gap ② to the specified limit by using a spark plug gap thickness gauge.
5. Reinstall the cleaned (or new) spark plug in the cylinder head, and tighten securely to the specified torque..

Spark plug torque: 8 lb-ft (11.2 N-m)

Air cleaner filter element

The air cleaner filter element should be serviced at regular intervals. Service the element more often when riding in unusually wet or dusty areas.

1. Open the passenger seat (see page 14).

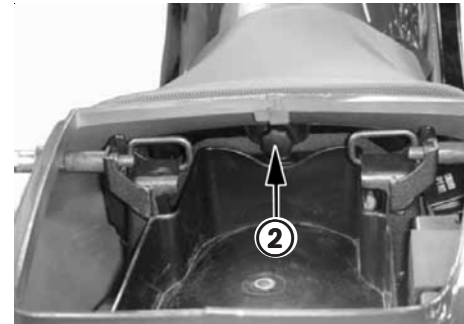

2. Remove the bolt securing the rider's seat ②.

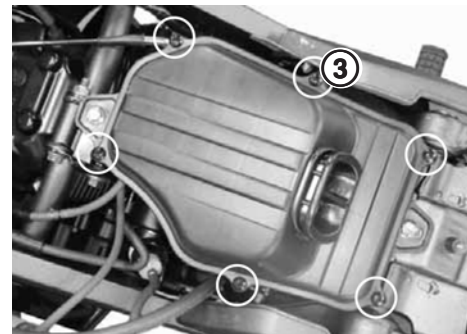

3. Remove the six air cleaner case cover screws ③.

- Remove the air cleaner element ④ by lifting it out of the air cleaner case.



- Based upon the element's condition and the Periodic Maintenance Schedule, clean or discard the element. If the element is not being replaced, blow the debris from the element with compressed air.



- Before installing the cleaned or new element, use a clean cloth to wipe the interior of the air cleaner box ⑤.

- Install a new air cleaner element. Use a genuine KYMCO air cleaner element, or an equivalent air cleaner element specified for your motorcycle.
- Complete the installation by reinstalling the air cleaner parts in the reverse order of removal.

⚠ CAUTION

Never use oil or solvent to wash the paper-type element.

Be careful to keep water from entering the air cleaner, as this may result in hard starting, or premature engine wear.

If the air cleaner element or cover is not installed properly, dirt may be drawn into the engine. This dirt can cause premature engine wear and affect engine performance.

Using the wrong KYMCO air cleaner element or other air cleaner element which is not of equivalent quality may cause premature engine wear or performance problems.

Throttle free play adjustment

Before each ride and during periodic maintenance, check for smooth throttle grip rotation from the fully open to the fully closed position at both full steering positions.

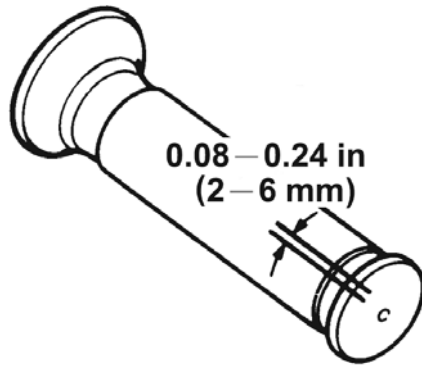

1. Measure the throttle grip free play at the throttle grip flange (per the illustration above).

Throttle free play: 0.08-0.24 in (2.0 - 6.0 mm)

2. Slide the protective rubber sleeve back on the throttle cable to expose the throttle cable adjuster.
2. Loosen the lock nut on the throttle cable, then turn the adjuster to obtain the correct free play.
3. Tighten the lock nut and reinstall the sleeve.

Brake fluid

With the motorcycle in an upright position, check the front and rear brake fluid level. The level should be above the lower level mark in both brake fluid reservoir. If the level is at or below the lower level mark "L", check the front and rear brake pads for wear (see page 24).



1. To adjust the brake fluid level to the upper level ⑥ in the front brake master cylinder reservoir, remove the two Phillips screws and lift off the cover.

To adjust the brake fluid level to the upper level ⑦ in the rear brake fluid reservoir, unscrew the plastic cap.

Brake fluid type: DOT 4 (from a sealed container)

⚠ WARNING

Worn brake pads should be replaced immediately. If the pads are not worn, have your brake system inspected for leaks. Do not ride your motorcycle unless the brakes are in perfect working order.

Do not mix brake fluids of different brands or ratings. This may cause brake failure and is very dangerous.

⚠ CAUTION

Brake fluid can damage plastic items, and painted and polished surfaces on your motorcycle. When servicing the brake fluid, use towels to cover and protect components on your motorcycle.

NOTE: Other brake system checks: Make sure there are no fluid leaks. Check for deterioration or cracks in the hoses and fittings. Contact your KYMCO dealer for any brake-related service needs.

Battery

Your KYMCO motorcycle is equipped with a maintenance-free (sealed) type battery, so it is not necessary to check the battery's electrolyte level or add distilled water.

⚠ CAUTION

Your battery is a maintenance-free type battery and can be permanently damaged if the cap strip is removed.

NOTE: If your battery seems weak and/or is leaking electrolyte (causing hard starting or other electrical troubles), contact your KYMCO dealer immediately.

NOTE: If your motorcycle is not going to be ridden for long period of time, the battery may discharge electricity by itself. Disconnect the battery's negative terminal and charge the battery periodically during storage.

NOTE: Always use a battery charger specifically designed for use on a maintenance-free type battery.

⚠ WARNING

Your motorcycle's battery gives off explosive hydrogen gas during normal operation. A spark or flame can cause the battery to explode with enough force to kill or seriously hurt you. Wear protective clothing and a face shield, or have a qualified technician perform the battery maintenance.

Battery removal

The battery is located in the battery box below the seat.

NOTE: Always keep the ignition switch OFF when servicing the battery.

1. Open and remove the passenger's and rider's seats (see pages 14 and 47).

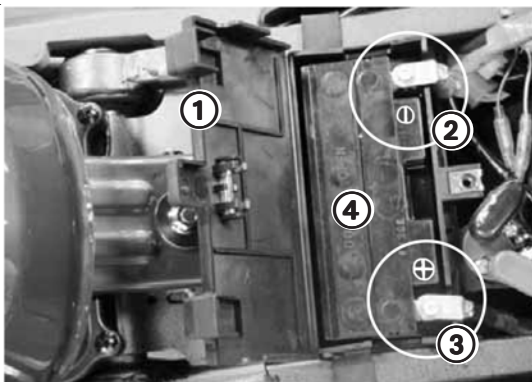

2. Lift up the battery cover ①.
3. Disconnect the negative (-) terminal lead ② from the battery first, then disconnect the positive (+) terminal lead ③.
4. Pull out the battery ④ from the battery box.
5. If the battery terminals are corroded, clean them with a wire brush, using mild soap and water.

6. After cleaning the terminals, apply a thin coat of dielectric grease on the terminals.

Battery installation:

Install the battery in the reverse order of the battery removal, connecting the positive lead (+) first, and then the negative lead (-).

Wire connectors & rubber covers

During the periodic maintenance check, make sure that wire connectors are secure, and that protective rubber covers are in good condition.

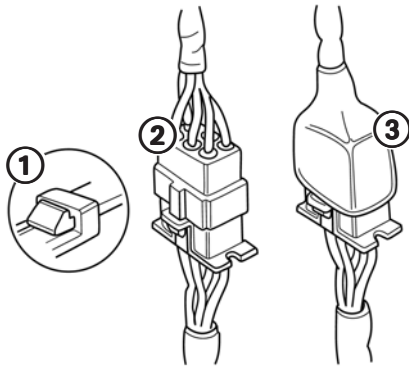

The tabs ① on the connectors should be engaged to ensure that the connectors stay fastened during riding, so there is no loss of electrical power.

While washing the motorcycle, take care to avoid spraying water directly on the connectors ②.

During service, pull the covers ③ back to clean off any moisture or debris.

Fuses

When frequent fuse failures occur, it usually indicates a short circuit or an overload in the electrical system.

Fuse list

15A ... **CHARGE** fuse protects battery charging system.

15A ... **IGNITION** fuse protects the ignition system and other systems.

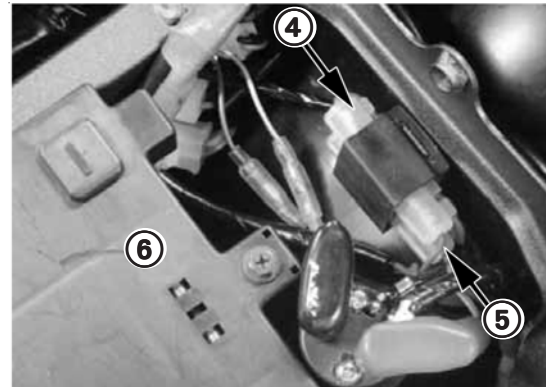

④ Ignition fuse (15A)

⑤ Charge fuse (15A)

⑥ The spare fuse is located on the inside of the battery cover

WARNING

Never use a fuse with a different rating from that specified. Serious damage to the electrical system or a fire may result, causing a dangerous loss of lights or engine power.

Cleaning

Clean your motorcycle regularly to protect the surface finishes, and inspect for damage or wear, and oil, coolant or brake fluid leakage.

Avoid cleaning products that are not specifically designed for motorcycle, scooter, or automobile surfaces. Nonspecific cleaners may contain harsh detergents or chemical solvents that can damage the metal, paint, and plastic on your motorcycle.

NOTE: If your motorcycle is still warm from recent operation, give the engine and exhaust system time to cool off before washing. Avoid the use of high pressure water spray (typical in coin-operated car washes), as the powerful spray can damage components on your motorcycle.

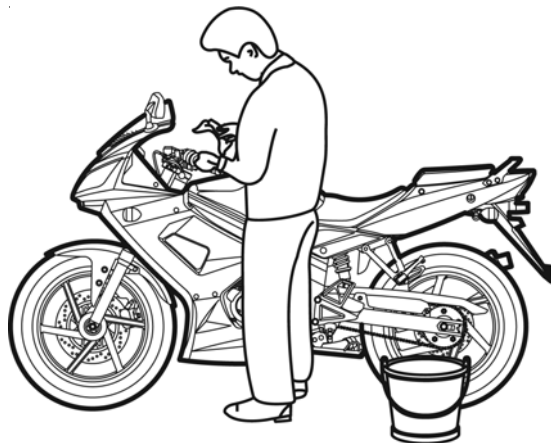

Washing your motorcycle

1. Rinse the motorcycle thoroughly with cool water to remove any loose dirt.
2. Clean the motorcycle with a sponge or soft cloth using cool water. Avoid directing water at the muffler outlet and electrical parts.
3. Clean the plastic parts using a cloth or sponge dampened with a solution of mild detergent and water. Rub the soiled area gently, rinsing it frequently with fresh water. Take care to keep brake fluid or other chemical solvents away from the motorcycle, as they will damage the plastic and painted surfaces.
4. After cleaning, rinse the motorcycle thoroughly with plenty of clean water. This rinsing is required to remove detergent residue which can corrode alloy parts.
5. Dry the motorcycle and then start the engine, allowing it to run for several minutes.

NOTE: The inside of the headlight lens may become clouded immediately after washing the motorcycle. Moisture condensation inside the headlight lens will disappear gradually as it is heated by the headlight. After washing, run the engine while keeping the headlight on, to dissipate any condensation.

6. Test the brakes before riding the motorcycle. Several applications of the brakes may be necessary to restore normal braking performance.

NOTE: Braking efficiency may be temporarily impaired immediately after washing the motorcycle, because the brake components are wet. Anticipate longer stopping distances to avoid a possible accident.

Finishing touches:

After washing your motorcycle, consider using a commercially-available spray cleaner/polish or a quality liquid or paste wax to enhance and protect the paint's finish. Use only a nonabrasive polish or wax made specifically for motorcycles, scooters, or automobiles. Apply the polish or wax according to the instructions on the container.

Windshield cleaning

Using plenty of water, clean with windshield with a soft cloth or sponge (avoid using detergents or any kind of chemical cleaner). Dry with a soft, clean cloth.

Removing road salt

The salt used in some areas to prevent road icing can be very corrosive to your motorcycle. Wash your motorcycle as soon as possible if it comes in contact with road salt (or sea water).

1. Clean the motorcycle using cool water (see page 53). Do not use warm water, as this will increase the corrosive effect of the salt.
2. Dry the motorcycle and protect painted and metal surfaces with wax or polish.

Painted aluminum wheel maintenance

Even if protected by paint, aluminum may corrode from contact with dirt, mud, or road salt. Clean the motorcycle's wheels with a wet sponge and mild detergent. Avoid stiff brushes, steel wool, or cleaners containing abrasives or chemical compounds.

After washing, rinse with plenty of water, and dry with a clean cloth. Apply touch-up paint to the wheels where damage has occurred.

Exhaust pipe maintenance

The exhaust system is painted and polished stainless steel, but it can become stained by oil or mud. If necessary, remove heat stains with a liquid kitchen-counter abrasive.

STORAGE GUIDE

Extended storage, such as for the winter months, requires that you take certain steps to reduce deterioration resulting from your motorcycle's inactivity. Whenever possible, perform any necessary periodic maintenance or repairs before storage, so the motorcycle will be in good condition when it is removed from storage.

Storage

1. Change the engine oil and filter.
2. Empty the fuel tank into an approved gasoline container, using a commercially available hand siphon, or an equivalent method. Spray the inside of the tank with an aerosol rust-inhibiting oil. Close the fuel filler cap on the fuel tank

WARNING

Gasoline is highly flammable and explosive. You can be burned or seriously injured when handling fuel. Stop the engine and keep heat, sparks, and flame away. Refuel the motorcycle outdoors and wipe up any spills immediately.

3. To prevent rusting in the cylinder, perform the following:
 - Remove the spark plug cap from the spark plug, and use tape or string to secure the cap to any convenient plastic body part so that it is positioned away from the spark plugs.
 - Remove the spark plug from the engine and store it in a safe, dry place. Do not connect the spark plug to the spark plug cap.

Pour a tablespoon (15 - 20 cc) of clean engine oil into the cylinder and cover the spark plug hole with a piece of cloth.

Crank the engine several times to distribute the oil.

Reinstall the spark plug and spark plug cap.

5. Remove the battery. Store it in an area protected from freezing temperatures and direct sunlight. Slow charge the battery once a month (use a quality charger designed for use on a maintenance-free type battery).
6. Wash and dry the motorcycle. Wax all painted surfaces. Coat the chrome or bare aluminum parts with rust-inhibiting oil.
7. Inflate the tires to their recommended pressures. Place the motorcycle on blocks to raise both tires off the ground.
8. Cover the motorcycle (don't use plastic or other coated materials) and store in an unheated area, free of excessive moisture, with a minimum of daily temperature variation. Do not store the motorcycle in direct sunlight, as the sun's UV rays can damage the body work and other components.

Removal from storage

1. Uncover and clean the motorcycle.
2. Change the engine oil if more than one month has passed since the start of storage.
3. Charge the battery as required (use a quality charger designed for use on a maintenance-free type battery). Install the battery.

⚠ CAUTION

Your battery is a maintenance-free type and can be permanently damaged if the cap strip is removed.

Charge the battery with a charger specifically designed for use with a maintenance-free type battery. Using another type of charger can damage the battery.

4. Drain any excess aerosol rust-inhibiting oil from the fuel tank. Fill the fuel tank with fresh gasoline.

⚠ WARNING

Gasoline is highly flammable and explosive. You can be burned or seriously injured when handling fuel. Stop the engine and keep heat, sparks, and flame away. Refuel the motorcycle outdoors and wipe up any spills immediately.

5. Perform a pre-ride inspection (see page 22). Test ride the motorcycle at low speeds in a safe riding area, away from traffic.

Troubleshooting

It can be frustrating if your motorcycle fails to start, or stops running while you are riding. In the rare instance this happens, take a few moments to check some items, and you may be back to riding your motorcycle soon.

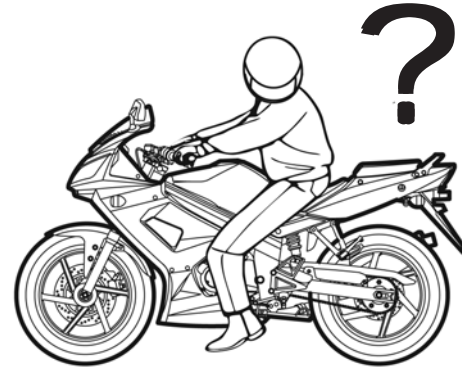

- ✓ Do you have enough gasoline in the fuel tank?
- ✓ Did you follow the correct procedure for starting the engine?
- ✓ Is the side stand in the "UP" position?
- ✓ Is the battery voltage low?
- ✓ Is the main fuse in good condition?

NOTE: Use this Owner's Manual to check components and make adjustments that are within your technical ability. If you cannot resolve the problem, do not hesitate to contact your KYMCO dealer for assistance.



DATE	MILEAGE	SERVICE PERFORMED & NOTES

Dimensions

Overall length	80.9 in (2057mm)
Overall width	28.5 in (725 mm)
Overall height	46.2 in (1174 mm)
Wheel base	53.3 in (1355 mm)
Seat height	31.4 in (800 mm)
Dry weight	299.8 lbs (136 kg)

Capacities

Engine oil	1.26 qt (1.2 L)
Fuel tank	3.5 US gal (13.5 L)
Maximum weight capacity	810 lbs (368 kg)

Engine

Type	Four-stroke, air-cooled OHC
Displacement	149.1 cc (9.1 cu. in)
Bore and stroke	2.44 in X 1.94 in (62 X 49.5 mm)
Compression ratio	10:1
Carburetion	Kymco CV type
Spark plug	NGK CR8E
Idle speed (dealer adjustment only)	1600 RPM
Starting system	Electric starter motor
Transmission	5-speed, foot shift
Clutch	Manual, wet multi-disc

Chassis

Tire size, front	110/80 - 17
Tire size, rear	140/70 - 17
Chassis material	Steel
Front suspension	Telescopic, dual tube-type
Front suspension travel	4.9 in (125 mm)
Rear suspension	Single shock absorber
Rear suspension travel	1.7 in (42.5 mm)
Brake (front)	Disc type (276 mm)
Brake (rear)	Disc type (220 mm)

Electrical

Ignition type	DC-CDI
Battery	12v-7Ah
Headlight	12v 60/55W X 2
Tail/brake light	12v5W/12v21W
Turn signal light	12v 10W X 4
Fuse (CHARGE)	15A
Fuse (IGNITION)	15A

Exhaust emission control system maintenance

The exhaust emission control system does not require extraordinary care to ensure its proper function. Adhere to the following procedures to make sure the system functions properly, so your motorcycle will not cause excessive pollution to the environment.

1. Make sure the air cleaner filter element is kept in good condition. See page 47 for cleaning procedures.
2. The engine oil should be changed regularly to promote proper engine efficiency and reduce pollutants that accumulate in used engine oil. Change the engine oil as specified in the maintenance schedule on pages 42 - 43 of this manual.
3. Use the proper type of gasoline. Your motorcycle's engine has been developed to use unleaded gasoline (see page 26 for the fuel recommendations). Using the improper type of fuel, such as a leaded fuel or fuel with performance-enhancing additives, will increase exhaust pollutants, and will reduce the efficiency of your motorcycle's engine.

WARNING

Immediately repair or replace any fuel or emission system component that will affect the efficiency and emission of your motorcycle.

Never modify your motorcycle, as improper modifications will affect the safety, the performance and emission output of your motorcycle.

Be aware that only an authorized KYMCO dealer has the tools, the expertise and the technical resources to properly diagnose and repair the emission system components on your Quannon motorcycle. Do not attempt to effect repairs of this type yourself or you might endanger the environment or your own safety.

KYMCO Clean-Air System

The KYMCO Clean-Air System is a secondary air suction system that helps the exhaust gases to burn more completely. When the engine's exhaust is sent into the exhaust system, it contains some unused fuel. This exhaust is still hot enough to burn the unused fuel. The Clean-Air system introduces more air so the oxygen will then permit the unused fuel to burn in the exhaust system. This continued burning action uses up a great deal of the normally unused fuel and other gases, as well as changing a significant portion of the poisonous carbon monoxide into harmless carbon dioxide. The Clean-Air system does not use any energy from the engine and does not affect the motorcycle's performance.

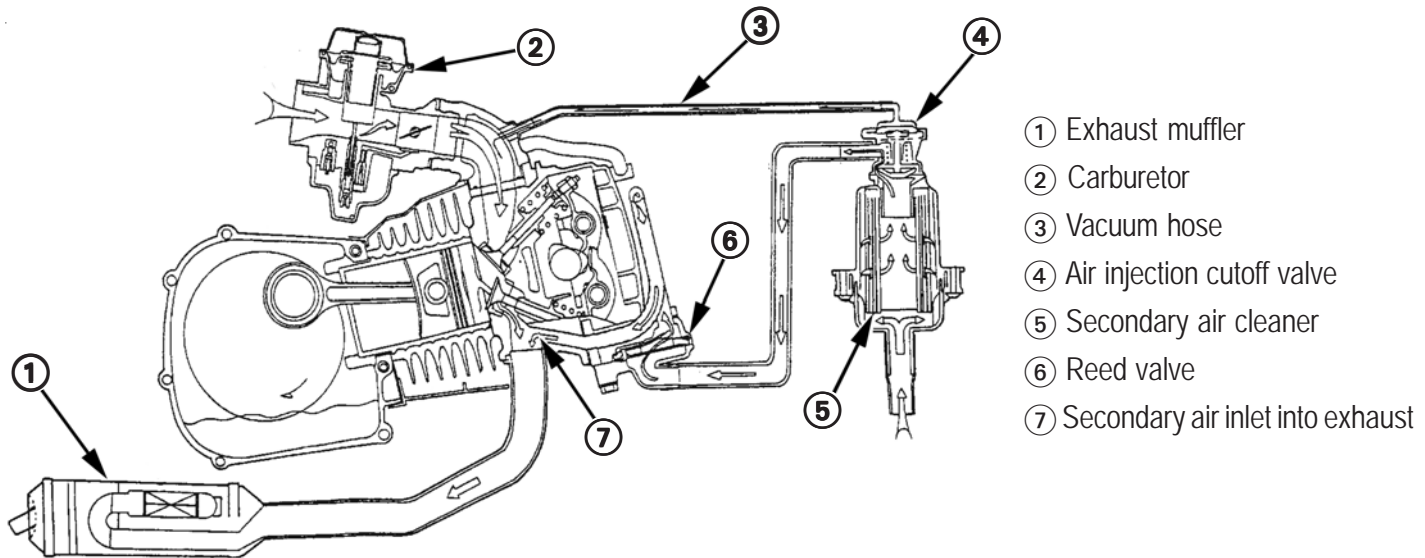

Crankcase Emission Control System

Your motorcycle's engine is equipped with a closed crankcase system. Blowby gases are routed back into the combustion chamber via the intake system. This system does not allow the blowby gases to enter the atmosphere.

Exhaust Emission Control System

The exhaust emissions from your Quannon motorcycle are controlled by engine design, factory-set fuel delivery, ignition settings, and exhaust system design.

Noise Exhaust Emission Control System

The engine, intake and exhaust systems of your motorcycle were designed to comply with federal, state and local noise level requirements. Do not modify the engine, intake or exhaust components, as doing so will affect compliance with these noise level requirements.

Please do not modify or change any KYMCO-designed components that may alter the sound or emission levels of your Quannon 150 motorcycle.

KYMCO LIMITED WARRANTY

NOISE EMISSIONS

KYMCO USA Inc, 5 Stan Perkins Road, Spartanburg, SC 29307, USA, warrants that this vehicle was designed, manufactured and equipped so that when new, it conforms with the applicable Motorcycle Noise Regulations of the United States Environmental Protection Agency ("EPA").

This warranty is not limited to any particular part, component or system of the vehicle. Defects in design, assembly, or in any part, component or system of the vehicle which, at the time of sale to the first purchaser, caused noise emission levels to exceed applicable Federal standards in effect at the time of manufacture, are covered by this warranty.



KYMCO MOTORCYCLE AND SCOOTER LIMITED WARRANTY

KYMCO USA, Inc. 5 Stan Perkins Road, Spartanburg, SC 29307 USA warrants for a period of twenty four- (24) months from the date of initial retail purchase from an authorized KYMCO dealer that each new KYMCO motorcycle or scooter shall be free, under normal use and maintenance, from any defect in material and workmanship subject to the following conditions, exclusions, obligations and limitations:

1. **EXCLUSIONS.** The following are specifically excluded from the terms and provisions of this warranty:
 - a. Any KYMCO motorcycle or scooter engaged in competitive racing or related use.
 - b. Any KYMCO motorcycle or scooter utilized for rental purposes.
2. **COVERAGE.** Any material or workmanship found to be defective by KYMCO within the warranty period and limitations shall be repaired without charge for parts or labor at any authorized KYMCO dealer located within the United States of America.
3. **WARRANTY PERIOD.** The warranty is effective from the date of purchase by the original owner with the following limitations:
 - SECTION 1 – All parts and repair labor are covered for the first 365 days.
 - SECTION 2 – Engine and electrical parts and repair labor are covered for the first 540 days.
 - SECTION 3 – Engine parts and repair labor are covered for 730 days.

4. **OWNERS OBLIGATIONS.** The following obligations must be fulfilled by vehicle's owner to maintain KYMCO warranty coverage:

- a. Owner must deliver the motorcycle or scooter to an authorized KYMCO dealer or equally qualified service facility for inspection, maintenance, services and adjustments according to the Periodic Maintenance chart contained in the owner's manual.
- b. All inspection, maintenance services and adjustments are to be performed at the owner's expense.

5. **LIMITATIONS.** This warranty shall not apply to or include any of the following:

- a. The normal expense of routine maintenance services and adjustments. This also includes parts that require replacement due to normal wear, such as spark plugs, drive chains, belt drives, air cleaner elements, brake shoes, cables, fuses, oils, coolants and tires.
- b. Damage from the lack of periodic maintenance, or damage resulting from repairs, adjustments, maintenance operations, or the use of non-genuine parts or accessories, fuel or fluids that do not follow KYMCO service recommendations.
- c. Damage caused by collision, improper operation, or caused by loading beyond the vehicle's rated load capacity.
- d. Damage caused by modifications made to the vehicle to increase performance.
- e. Damage caused by improper storage or transport, or towing or transportation expenses to move the vehicle to a KYMCO dealer for service or repair.
- f. Damage caused by natural disasters such as fires, floods, collision or theft, or any damage caused by the passage of time such as fading, peeling or other deterioration caused by outside elements.
- g. Repair or replacement of worn items caused by the use of the motorcycle or scooter and normal, operational characteristics such as engine sounds, vibration, seepages (and other situations not considered defects by KYMCO).

6. **LIMITED LIABILITY.**

- a. The liability of KYMCO under the twenty four- (24) month warranty is limited solely to the remedying of defects materials or workmanship by an authorized KYMCO dealer at its place of business during customary business hours. This warranty does not cover inconvenience or loss of use of the motorcycle or scooter, or transportation of the motorcycle or scooter to or from a KYMCO dealer.

KYMCO SHALL NOT BE LIABLE FOR ANY OTHER EXPENSE, LOSS OR DAMAGE, WHETHER DIRECT, INCIDENTAL, CONSEQUENTIAL OR EXEMPLARY ARISING IN CONNECTION WITH THE SALE OR USE OF, OR INABILITY TO USE, THE KYMCO MOTORCYCLE OR SCOOTER FOR ANY PURPOSE. SOME STATES DO NOT ALLOW THE EXCLUSION OR LIMITATION OF ANY INCIDENTAL OR CONSEQUENTIAL DAMAGES, SO THE ABOVE LIMITATION OR EXCLUSION MAY NOT APPLY TO YOU.

- a. NO EXPRESS WARRANTY IS GIVEN BY KYMCO WITH RESPECT TO THE KYMCO MOTORCYCLE OR SCOOTER EXCEPT AS SPECIFICALLY SET FORTH HEREIN. ANY WARRANTY IMPLIED BY LAW, INCLUDING ANY WARRANTY OF MERCHANTABILITY OR FITNESS FOR A PARTICULAR PURPOSE, IS EXPRESSLY LIMITED TO THE TWENTY FOUR- (24) MONTH WARRANTY TERM SET FORTH HEREIN. THE FOREGOING STATEMENTS OF WARRANTY ARE EXCLUSIVE AND IN LIEU OF ALL OTHER REMEDIES. SOME STATES DO NOT ALLOW LIMITATIONS ON HOW LONG AN IMPLIED WARRANTY LASTS, SO THE ABOVE LIMITATIONS MAY NOT APPLY TO YOU.
 - b. No dealer is authorized to modify this KYMCO Limited motorcycle or scooter Warranty.
7. **LEGAL RIGHTS.** THIS WARRANTY GIVES YOU SPECIFIC LEGAL RIGHTS, AND YOU MAY ALSO HAVE OTHER RIGHTS WHICH VARY FROM STATE TO STATE.

Accessories & Modifications	6	Fuel Level Inspection & Refilling	26	Right-hand Handlebar Switch	12
Air Filter Element	47 - 48	Fuses	52	Seat Lock	14
Battery Removal & Service	51	Helmet Lock	14	SECTION 1 - SAFETY	2 - 8
Battery	50 - 51	Horn Inspection	28	SECTION 2 - CONTROLS & FEATURES	9 - 21
Brake Fluid	49 - 50	Identification Numbers Record...(inside of back-cover)		SECTION 3 - OPERATION	22 - 40
Brake Inspection	24	Ignition Switch	10	SECTION 4 - MAINTENANCE	41 - 58
Break-in Recommendations	39 - 40	Importance of Maintenance	41	Serial Numbers	9
CA Prop 65 & Battery Warning(inside of front-cover)		Index	64	Spark Plug	46 - 47
Caution & Warning Labels	6	Keys	10	Specifications	59
Chassis Inspection	31	KYMCO Limited Motorcycle Warranty	63	Speedometer	17
Clean-air System	61	Left-hand Handlebar Switch	13	Starting the Engine	31 - 33
Cleaning Your Motorcycle	53 - 54	Lights Inspection	27	Steering Inspection	27
Clock	20 - 21	Load Limits & Guidelines	5	Steering Lock	10 - 11
Clutch Lever & Cable Inspection	29	Locations of Parts & Controls	7 - 8	Stopping & Parking Your Motorcycle	37 - 38
Drive Chain Inspection	28	Maintenance Record	57 - 58	Storage	55 - 56
Emission Information & EPA Warranty	62	Maintenance Schedule	42 - 43	Table of Contents	1
Engine Oil Change	44 - 45	Manual Icon Legend	(inside of front-cover)	Throttle Free-play Adjustment	49
Engine Oil Inspection	23	Motorcycle Safety	3 - 4	Throttle Inspection	30
Engine Oil Recommendation	44	Multifunction Meter	15 - 21	Tire Break-in	40
Exhaust Emissions System	60 - 61	Odometer/Trip meter/Service meter	18 - 19	Tire Inspection	25
Forward	2	Pre-ride Inspection	22 - 31	Tool Kit	14
Fuel Level Gauge	20	Riding Your Motorcycle	37 - 40	Wire Connectors	52

Identification Numbers Record

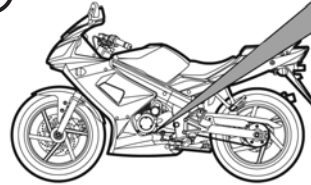
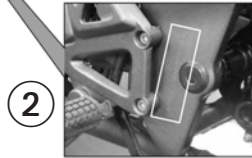
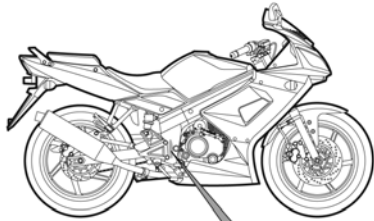

1. IGNITION SWITCH KEY IDENTIFICATION NUMBER

The ignition switch key identification code is stamped on tab ① supplied with the key. If you require a replacement key, you will need this code to obtain a new key from your authorized KYMCO dealer. Record the key number in the box above.

2. VEHICLE IDENTIFICATION NUMBER (VIN)

3. ENGINE SERIAL NUMBER (ESN)

Record the Vehicle Identification Number ② and Engine Serial Number ③ in the boxes above for future reference (to assist you in ordering parts from your authorized KYMCO dealer or for reference in case the vehicle is stolen).



**5 Stan Perkins Road
Spartanburg, SC 29307
Telephone: (888) 235-3417
FAX: (864) 327-4745**

**Prepared October 2008
T300-RA30FA-US-A5**